



# **SHADOW**

TRACE 2.0

DRAFT

CXrL

February 1, 2002

Copyright ©1990 Center for X-ray Lithography

Permission to use and copy this software and its documentation for internal use of licensed user unless otherwise specified in written licensing agreement and without fee is hereby granted, provided that the above copyright notice appear in all copies and that both the copyright notice and this permission notice appear in supporting documentation, and that the name of the University of Wisconsin and Center for X-ray Lithography not be used in advertising or publicity pertaining to distribution of the software/documentation without specific, written prior permission. The University of Wisconsin makes no representations about the suitability of this software for any purpose. It is provided “as is” without express or implied warranty.

THE UNIVERSITY OF WISCONSIN DISCLAIMS ALL WARRANTIES WITH REGARD TO THIS SOFTWARE, INCLUDING IMPLIED WARRANTIES OF MERCHANTABILITY AND FITNESS. IN NO EVENT SHALL THE UNIVERSITY OF WISCONSIN BE LIABLE FOR ANY SPECIAL, INDIRECT OR CONSEQUENTIAL DAMAGES OR ANY DAMAGES WHATSOEVER RESULTING FROM LOSS OF USE, DATA OR PROFITS, WHETHER IN AN ACTION OF CONTRACT, NEGLIGENCE OR OTHER TORTIOUS ACTION, ARISING OUT OF OR IN CONNECTION WITH THE USE OR PERFORMANCE OF THIS SOFTWARE.

Authors: Franco Cerrina, Chris Welna, G.J. Chen, and M. Sanchez del Rio  
Center for X-ray Lithography, University of Wisconsin



# Contents

<b>1</b>	<b>Introduction</b>	<b>1</b>
<b>2</b>	<b>Optical Layout</b>	<b>7</b>
2.1	Reference Frames . . . . .	7
2.2	Input for Geometry of Element . . . . .	9
2.2.1	Incidence Angle: . . . . .	11
2.2.2	Source Distance: . . . . .	13
2.2.3	Reflection Angle: . . . . .	15
2.2.4	Image Distance: . . . . .	17
2.2.5	Orientation Angle . . . . .	19
2.3	Optaxis and System Layout . . . . .	20
<b>3</b>	<b>Surface Types available</b>	<b>23</b>
3.1	Element Shapes . . . . .	23
3.1.1	Mirror Surface . . . . .	24
3.2	Options for standard figures . . . . .	27
3.2.1	Cylindrical Mirror . . . . .	28
3.2.2	Convex/Concave Option . . . . .	30
3.2.3	Mirror Dimensions . . . . .	32
3.2.4	Distorted Surface . . . . .	34
3.2.5	Surface Roughness . . . . .	36
<b>4</b>	<b>Object Types</b>	<b>39</b>
4.1	Mirror . . . . .	40
4.2	Lens . . . . .	43
4.3	Gratings . . . . .	47
4.4	Crystals . . . . .	51
4.5	Compound Mirrors . . . . .	53
4.6	Capillaries and Kumakhov Lenses . . . . .	57
4.7	Fresnel Zone Plate . . . . .	60

4.8	Screens . . . . .	63
<b>5</b>	<b>Optical Properties</b>	<b>65</b>
<b>6</b>	<b>Misalignments to the system</b>	<b>69</b>
6.1	Source Movement . . . . .	70
6.2	Mirror Movement: . . . . .	72

# Chapter 1

## Introduction

The SHADOW program was started in 1981. Although completely general, it has been optimized for calculations involving synchrotron radiation and x-ray optics. SHADOW calculations are divided into two parts, SOURCE and TRACE, accompanied by a host of pre- and post-processor utilities.

The SOURCE portion of the program generates a set of rays that sample the source distribution (the brightness function), typically a synchrotron bending magnet or an undulator. The basic parameters are the source shape and size, depth and divergence. Additionally, information on photon energy, phase, polarization and optical path can be generated. The source is thus a collection of up to 5000 rays described by their starting position, direction, energy, phase and polarization. The *User's Guide for the Source* describes the necessary input in detail.

The second part, TRACE, sets up the optical system and executes the ray-tracing of the source through the system. The optical system as such is a collection of separate optical elements, each a virtual object. The elements are specified independently and ray-traced separately. Information is passed between consecutive elements by files written at intermediate (virtual) image planes. Each optical element needs a basic set of information:

**Geometry:** The geometry includes the distance before and after the element, the incidence angle and the orientation.

**Surface** The figure of the element and any modifications to the ideal 3-D shape.

**Element type** The element type is a choice between a mirror, lens, grating, crystal, capillary, compound mirror, Fresnel zone plate, slit or filter.

**Optical properties** The user can then add optical properties to account for reflectivity losses.

**Misalignments** misalignments can be tested on the system.

This manual assumes that the user has successfully generated a SHADOW source file (BEGIN.DAT) and knows the basics of using the different input modes. More information can be found in the User's Guide for the Source and in the SHADOW Primer. Additionally, comments on this document and other suggestions or questions about the program can be electronically mailed to: shadow@xraylith.wisc.edu.

## An Optical System

At this point, an optical system will be added to the source. A sample layout is shown in Figure 1.1. The optical system (OS) is broken down into individual optical elements (OE's), each element specified separately in the program. The concept of a continuation plane (CP) is used to link the elements together. The continuation plane is an imaginary point in space between consecutive elements where the output of one element becomes the input of the next element.

TRACE creates several files for each optical element:

**START.OX** contains the input parameters for the element X. Created by TRACE in either Prompt or Menu mode.

**END.OX** contains the parameters for element X after the element has been TRACEd. Different from START.OX. May also contain calculated mirror parameters, calculated rotation angle for gratings, crystals.

**MIRR.OX** contains the information for each ray immediately after it is intercepted with the element surface. Binary format readable and plottable by PLOTXY, PREPLOT, HISTO1, TRANSLATE. In mirror reference frame.

**STAR.OX** contains the information for each ray at the continuation plane of that element. Binary format.

**OPTAX.OX** contains the location of the element and continuation plane in the laboratory reference frame.

**SCREEN.OX0Y** contains information for each ray at any specified position along an element X. Binary format. Optional. Can be simple view port, slit/obstruction or filter.

As an example, let's say the system shown in Figure 1.1 has the first mirror at 10m from the source, the second mirror at 12m from the source, the final image at 20m. Figure 1.2 shows how the distances that SHADOW uses add cumulatively. So, optical element one has a source distance of 10m and an image distance of 1m, optical element two has a source distance of 1m and an image distance of 8m (along the optical axis). The intermediate plane may have no value optically, however it is here that SHADOW passes the ray information from one element to the next. Optical element two uses the image file of optical element one (STAR.01) as its source. If there happens to be an



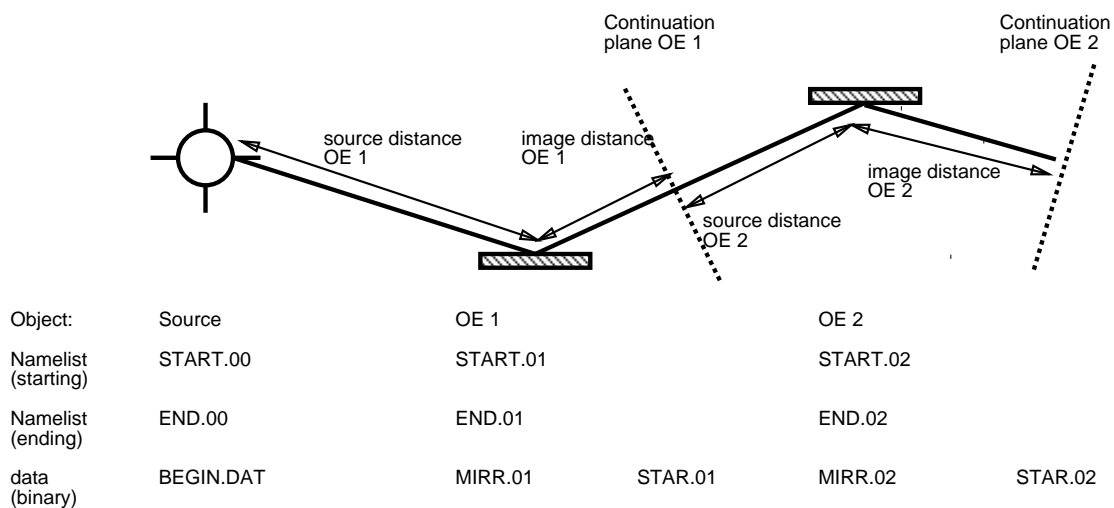

Figure 1.1: Sample layout with source and optical system.

intermediate image between two elements, the continuation plane can be placed coincident with the image, it does not need to be halfway between the elements.

In general, the system of units used in SHADOW are completely arbitrary. It is up to the user to enter values consistently in both the source and optical system. Where it is required that the value be in specific units, SHADOW will ask for the value in degrees, centimeters, etc.

## Data Formats

The binary data files carry information about each ray that is traced through the system. For an 18 column file, the values are shown in table 1.1, 12 and 13 column files are the same, only truncated at the appropriate column. The data files contain the position of each ray in columns 1, 2, and 3, the direction in 4, 5, and 6, the parallel polarization vector in 7,8,9, column 10 is a flag for whether the ray is good or lost, column 11 holds the photon energy or wavelength of the ray in the form of the wavenumber, column 12 is the index for the ray. The additional columns hold the optical path (13), the parallel and perpendicular phase (14,15) and the perpendicular polarization vector (16,17,18). Two or three columns can be extracted using PREPLOT, all the columns can be written in ASCII using TRANSLATE.

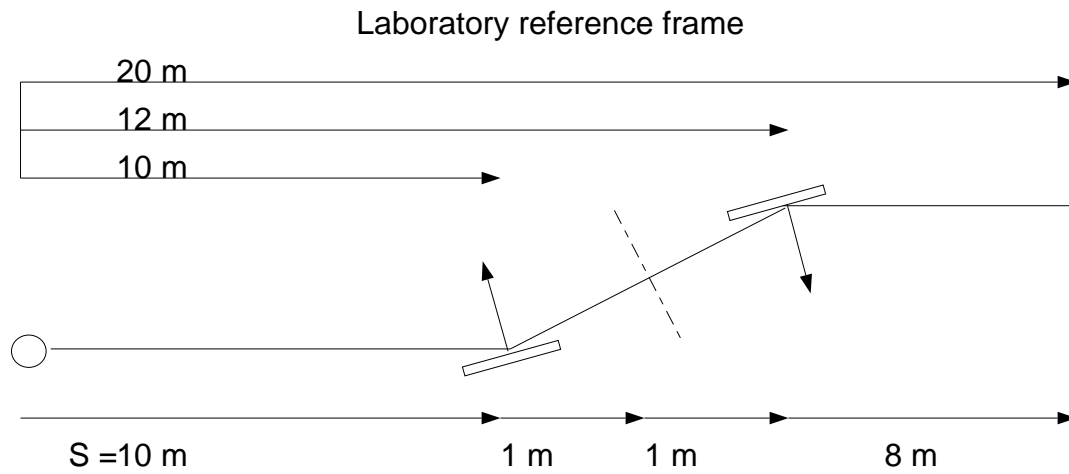

Figure 1.2: Sample layout with distances.

X	Y	Z	Spatial coordinate
X'	Y'	Z'	Direction
Asx	Asy	Asz	EM vector (s-)
FF	q	kk	Flag, wavenumber, ray index
opd	Fs	Fp	optical path length, phases
Apx	Apy	Apz	EM vector (p-)

Table 1.1: Information stored in binary files.

## **The rest of the User's Guide**

The breakdown of this manual is meant to convey several independent sections available when defining an element. For example, the figure of an element is independent of whether it is a mirror, a lens, a grating or a crystal. The following chapters will cover the TRACE segment broken down into the kinds of information needed and objects available:

- Geometry of element
- Surfaces available
- Objects available
- Optical properties specification
- Misalignments to system
- Extra information available.



## Chapter 2

# Optical Layout

This chapter covers the physical layout of a system and its elements by defining the reference frames and showing the user how to enter the correct parameters.

SHADOW defines an optical system to be made up of a set of independent optical elements. The output of one element becomes the input of the next element. As the elements are defined one at a time they are added to the end of the system. Elements can also be inserted or deleted from the sequence using the MENU mode. SHADOW traces all the rays through one element at a time, e.g. all data is calculated and files written for element one before the program looks at element two.

### 2.1 Reference Frames

SHADOW uses two reference frames. The first is fixed, and is the laboratory reference frame. It provides a global environment to describe the propagation of the beam. The second reference frame is local and can be perceived as rotating with the orientation of each individual element. Most of the information SHADOW provides will be in the second reference frame. We define a coordinate system at the source as shown in Figure 2.1 with X and Z defining the cross section space and Y defining the depth and ultimately the direction of travel. The optical axis or central ray exits from the origin of this reference frame with zero angle. It intersects the element at the element center with the specified nominal incidence angle. The local reference frame at the element has the central ray in the Y-Z plane, the tangent to the surface in the X-Y plane and the normal to the surface at the origin defined as Z.

*The orientation of each element is relative to the previous element.* Figure 2.2 shows how the coordinate systems rotate for a single element with different orientations.

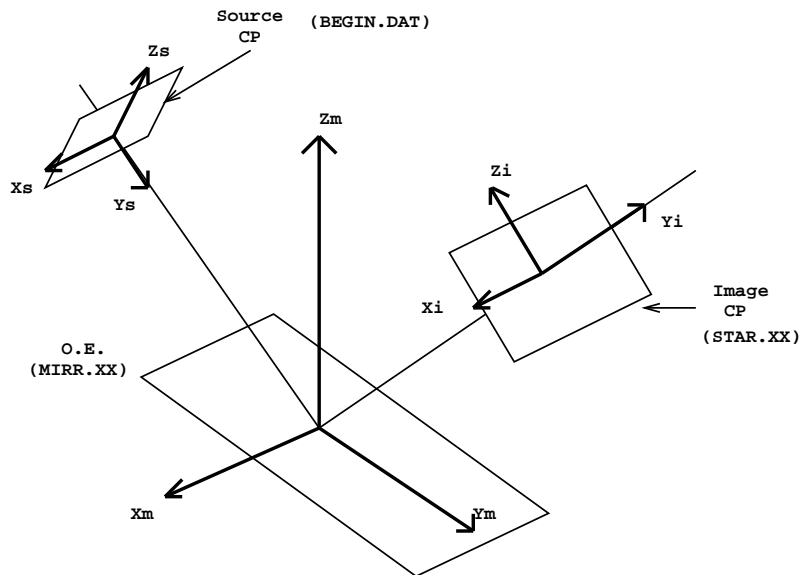

Figure 2.1: Reference frames in SHADOW

---

## **2.2 Input for Geometry of Element**

SHADOW starts by defining the physical location and position of the optical element relative to the previous element. Several questions are asked about the geometry of the system. The program needs the distance before and after the element, the incidence angle of the central ray, and the relative orientation of the element. For each input, we explain what SHADOW requires and show the corresponding PROMPT and MENU sessions.

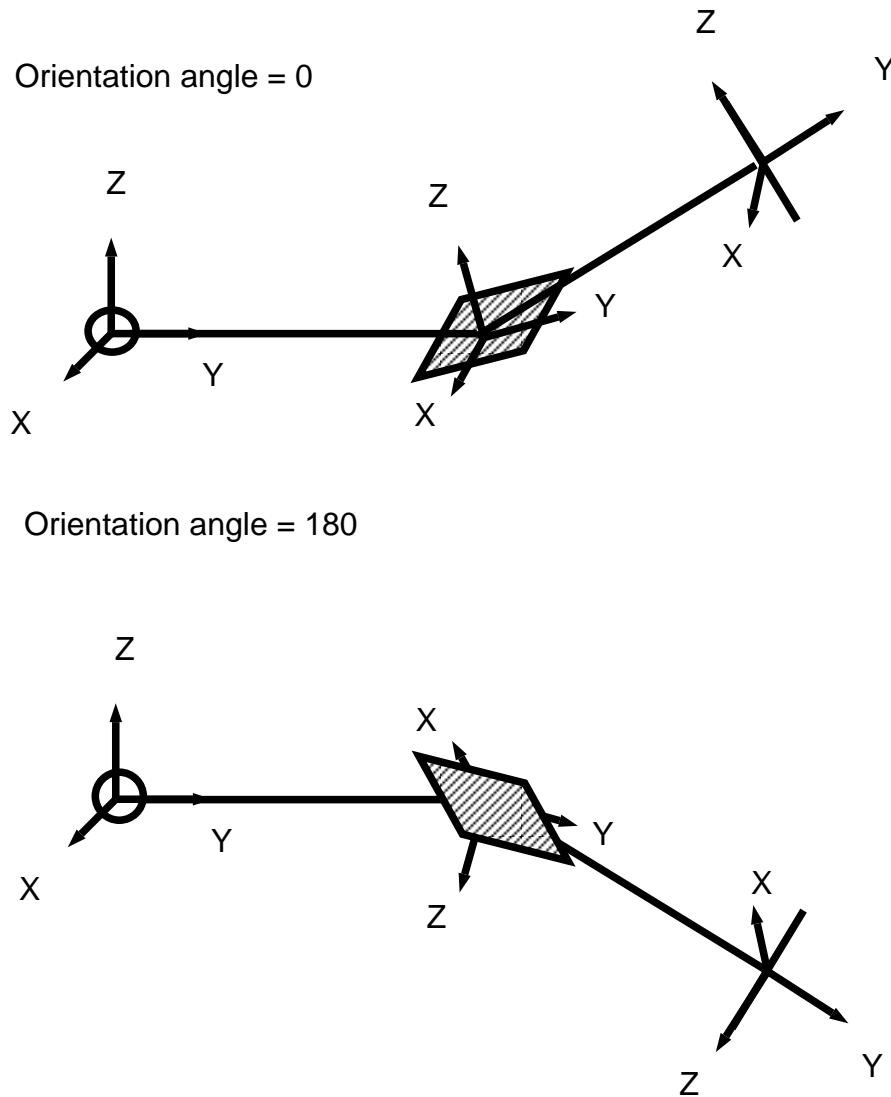

Figure 2.2: Orientation angle demonstration



### 2.2.1 Incidence Angle:

PROMPT:

Let's define the optical or central axis of the system for this particular optical element.  
 By this I mean a "virtual" line that runs throughout the optical system. Along this line are located the "continuation" planes, where the OS is subdivided in the individual OE. This line does not have to coincide with the true optical axis, as it is used mainly for bookkeeping the data, but it helps greatly in the data analysis if this identity is preserved as everything in the program is referred to it.  
 Once established, you still have complete freedom of "moving" around the mirrors.  
 In the case of a grating, you will have several choices. The program may override your specifications for the central axis and locate the source and image at the "best" position. You will be prompted later for this option.  
 It is recommended to use CM as units. This is not critical for most cases, but it is in the case of diffraction elements.  
 Optical Element definition:  
 Incidence Angle ? 88

MENU:

MAIN MENU	Optical Element 1
Files to write out	ALL
Source plane distance	0.0000000000000E+00
Image plane distance	0.0000000000000E+00
Incidence angle	88.000000000000E+00
Reflection angle	0.0000000000000E+00
Mirror Orientation Angle	0.0000000000000E+00
Source file	BEGIN
Type of element (+)	REFLECTOR
Figure (+)	PLANE
Diffraction (+)	MIRROR
Crystal (+)	NO
Mirror movement (+)	NO
Ripple Surface (+)	NO
Exit Slit (+)	NO
Source Movement (+)	NO
Goto OE (+)	

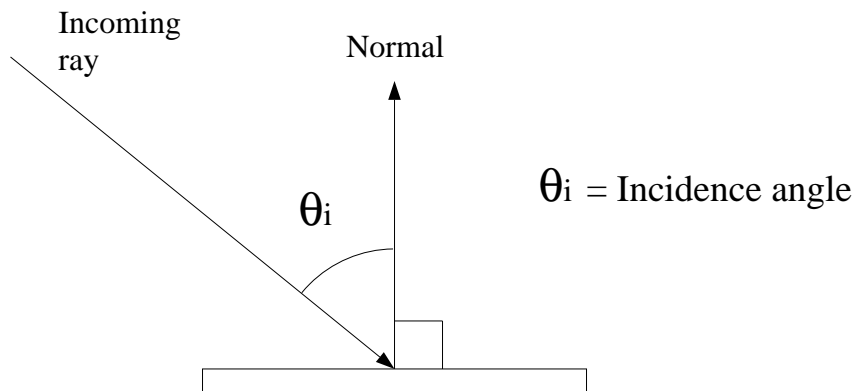

Figure 2.3: Incidence angle

The incidence angle is the angle at which the central ray of the beam hits the optical element, measured down from the normal to the surface of the optical element. SHADOW expects a real number entered in units of *degrees*. It is independent of the orientation angle of the element. Figure 2.3 shows how the incidence angle is measured.

---

**Example:** The incidence angle can be varied to model different optical systems from grazing angle systems to normal incidence systems. For example, a 2 degree *grazing angle* would be input to SHADOW as *88 degrees*.

Notice that the user has complete freedom of specifying incidence angles even  $\leq 0$  or larger than 90 degrees, as long as the user understands how to interpret the results.

**2.2.2 Source Distance:**

PROMPT:

```
Optical Element definition:
Incidence Angle ? 88
Source Distance ? 2000
```

MENU:

```

MAIN MENU                                Optical Element 1
Files to write out                        ALL
Source plane distance                     2000.000000000000E+00
Image plane distance                      0.0000000000000000E+00
Incidence angle                           88.00000000000000E+00
Reflection angle                           0.0000000000000000E+00
Mirror Orientation Angle                   0.0000000000000000E+00
Source file                                BEGIN

Type of element (+)                       REFLECTOR
Figure (+)                                PLANE
Diffraction (+)                           MIRROR
Crystal (+)                                NO
Mirror movement (+)                        NO
Ripple Surface (+)                         NO
Exit Slit (+)                              NO
Source Movement (+)                        NO
      Goto OE (+)
```

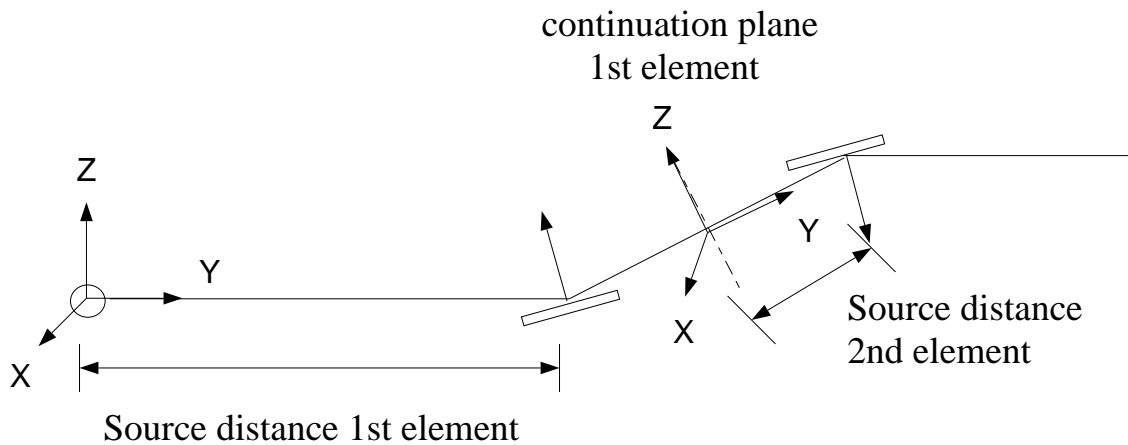

Figure 2.4: Source distance geometry

The source distance, or source plane distance, is the distance along the  $Y$  axis from the source continuation plane or previous continuation plane to the current optical element in the system. It is not necessary for this distance to be the true object distance of an optical element and is useful for specifying some special cases. (See figure 2.4.) The distance can even be negative and the rays will then be traced backwards. SHADOW expects a real number in units consistent with the units of length used in the rest of the definition of the element and those used in the source.

---

**Example:**

The user can set this variable to accurately model his optical system.

**2.2.3 Reflection Angle:**

PROMPT:

```

Optical Element definition:
Incidence Angle ? 88
Source Distance ? 2000
Reflection Angle? 88

```

MENU:

MAIN MENU	Optical Element 1
Files to write out	ALL
Source plane distance	2000.0000000000E+00
Image plane distance	0.0000000000000E+00
Incidence angle	88.000000000000E+00
Reflection angle	88.000000000000E+00
Mirror Orientation Angle	0.0000000000000E+00
Source file	BEGIN
Type of element (+)	REFLECTOR
Figure (+)	PLANE
Diffraction (+)	MIRROR
Crystal (+)	NO
Mirror movement (+)	NO
Ripple Surface (+)	NO
Exit Slit (+)	NO
Source Movement (+)	NO
Goto OE (+)	

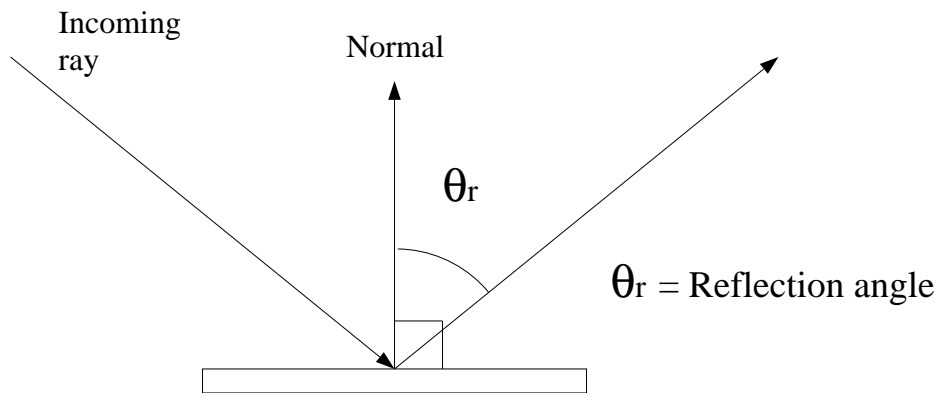

Figure 2.5: Reflection angle

The “reflection angle” is so called by convention; it is the angle that the reflected or refracted central ray makes with the normal to the surface of the optical element. For most purposes it is set equal to the incidence angle shown in figure 2.5 but in many cases it is not necessarily so (e.g. asymmetric diffraction gratings). The reflection angle should be entered as a real number in units of degrees. In the case of a grating or a crystal, SHADOW may calculate the reflection angle to satisfy equations at specific energies. For more information, see the sections on gratings and crystals.

---

**Example:**

The reflection angle should be equal to the incidence angle in most cases.

**2.2.4 Image Distance:**

PROMPT:

```

Optical Element definition:
Incidence Angle ? 88
Source Distance ? 2000
Reflection Angle? 88
Image Distance ? 500

```

MENU:

MAIN MENU	Optical Element 1
Files to write out	ALL
Source plane distance	2000.0000000000E+00
Image plane distance	2000.0000000000E+00
Incidence angle	88.000000000000E+00
Reflection angle	88.000000000000E+00
Mirror Orientation Angle	0.00000000000000E+00
Source file	BEGIN
Type of element (+)	REFLECTOR
Figure (+)	PLANE
Diffraction (+)	MIRROR
Crystal (+)	NO
Mirror movement (+)	NO
Ripple Surface (+)	NO
Exit Slit (+)	NO
Source Movement (+)	NO
Goto OE (+)	

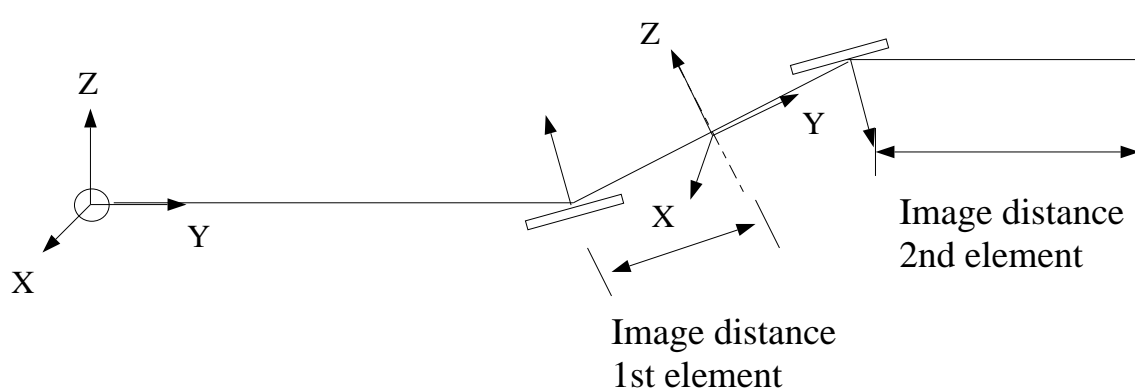

Figure 2.6: Image distance geometry

The image distance, or image plane distance, is the distance along the  $Y$  axis from the optical element to its continuation plane. The continuation plane then serves as the source for the next optical element. This distance may or may not be where the image is located and can even be negative or zero. In general it is located somewhere between the two elements. Figure 2.6 shows the image distance for two different elements.

SHADOW expects a real number in units of length consistent with previously defined elements and the source.

---

**Example:**

The image plane is located somewhere between two consecutive optical elements. Its primary function is to serve as a convenient place to pass the results of one optical element into the next. If plotted, it shows information about the beam at that point including the cross section and the phase space plots. Thus it is convenient to locate it at a focus or some special point. It can be the location of an actual image, but in many cases will not.



### 2.2.5 Orientation Angle

PROMPT:

Mirror orientation angle. Angles are measured CCW, in deg, referring to the mirror normal. Alpha=0 is the mirror sitting at the origin, facing up. Alpha = 90 is the mirror standing at your right and facing left when you look along the beam STANDING ON THE PREVIOUS MIRROR and so on.  
Orientation Angle [ Alpha ] ? 0

MENU:

MAIN MENU	Optical Element 1
Files to write out	ALL
Source plane distance	2000.0000000000E+00
Image plane distance	2000.0000000000E+00
Incidence angle	88.000000000000E+00
Reflection angle	88.000000000000E+00
Mirror Orientation Angle	0.00000000000000E+00
Source file	BEGIN
Type of element (+)	REFLECTOR
Figure (+)	PLANE
Diffraction (+)	MIRROR
Crystal (+)	NO
Mirror movement (+)	NO
Ripple Surface (+)	NO
Exit Slit (+)	NO
Source Movement (+)	NO
Goto OE (+)	

The orientation angle is used to define the *relative* orientation of two elements. It is measured from the pole or normal of an element to the pole of the previous element. Rotations are made about the  $Y$ -axis counter-clock-wise from a zero position corresponding to the normal of the previous optical element. The rotation is shown in figure 2.7. If defining the first element, the zero position is the mirror “facing up” with the element pole coincident with the positive  $Z$ -axis. A convenient way of remembering the rule is to imagine “sitting” on the previous element and looking down the central ray to the next OE. If the normal is seen facing upward, then  $\alpha = 0$ . If it is facing to the left, then  $\alpha = 90$  degrees, and so on.

---

**Example:** For example a Toroidal Grating Monochromator (TGM) beamline has its elements in the following positions; mirror 1 faces the floor, the grating faces the ceiling, and the refocus mirror again faces the floor. The correct orientation angles for each element would be  $180^\circ$ ,  $180^\circ$ , and  $180^\circ$ : the first mirror is 180 degrees from the zero position, the second element, although seemingly in the zero position, is 180 degrees from the position of the last mirror, likewise, the third mirror is 180 degrees from the second element. The layout is shown in figure 2.8 as well as another example of orientations.

## 2.3 Optaxis and System Layout

Setup, I/O files, OPTAX

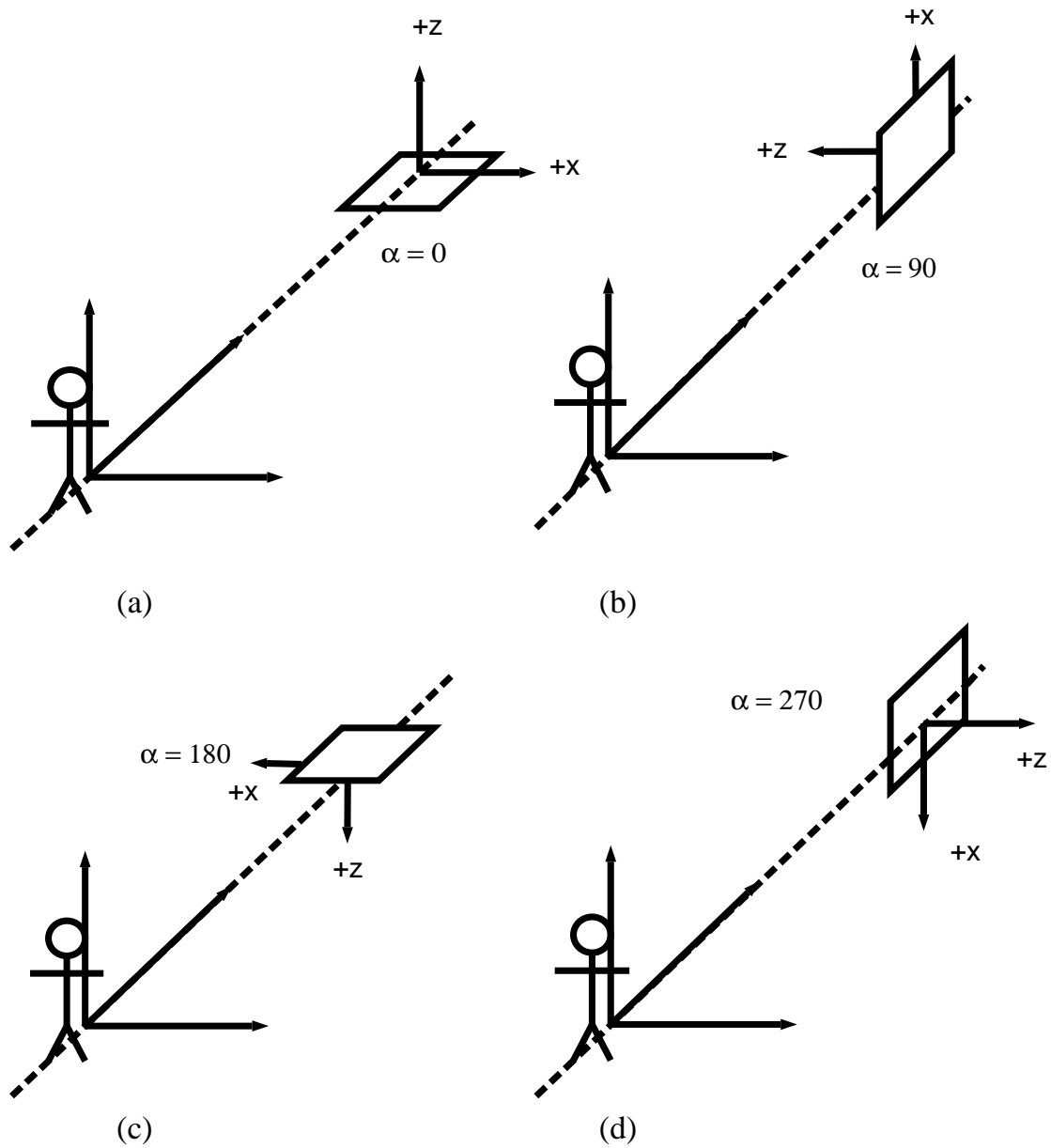

Figure 2.7: Example of four different orientations.

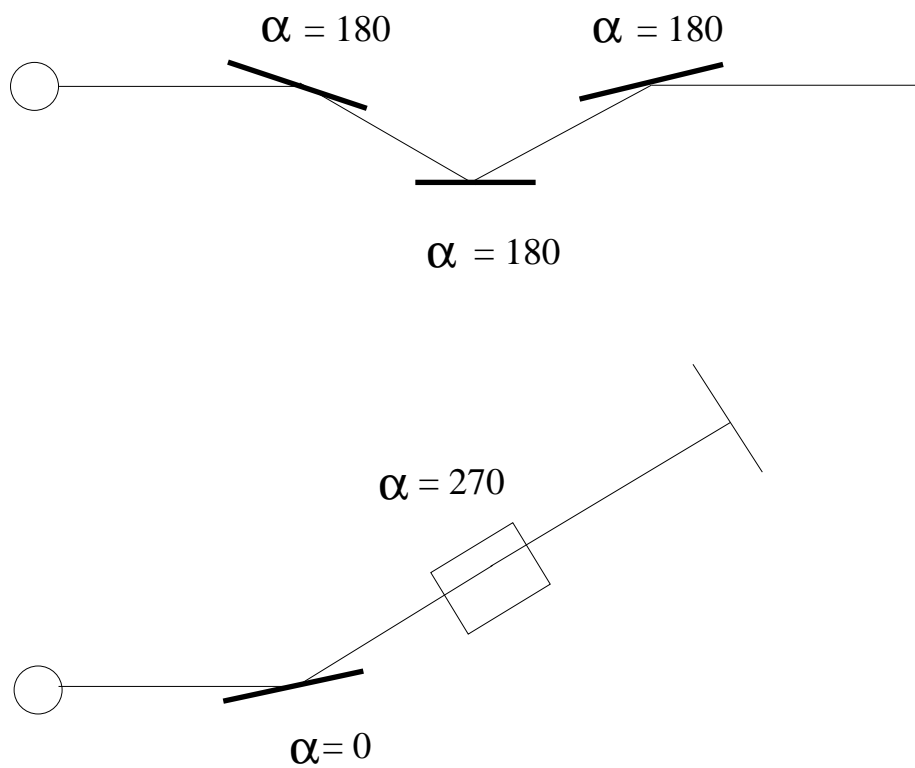

Figure 2.8: Orientation angle examples.

## Chapter 3

# Surface Types available

This chapter will cover the surface shapes available in SHADOW, and various modifications that can be made to them. These modifications include creating cylindrical mirrors and convex or concave surfaces, putting physical limits on the mirror size and shape, and adding error surfaces, and surface roughness.

To compute a geometrical reflection, SHADOW starts with the vector for each ray at the previous image plane (or source). The equation representing the mirror surface is calculated either with user specified parameters or with input focal conditions. The intercept point of each ray and the element surface is found and the normal at each point calculated. From this information, we can find the incidence angle and calculate the outgoing direction. If the intercept between the ray and the surface is a complex solution, the ray is considered to be a “hard loss” and all values besides flag and index are set to zero.

### 3.1 Element Shapes

There are nine basic element figures available within SHADOW: spherical, elliptical, toroidal, parabolical, plane, codling slit, hyperbolic, conical and polynomial. The different parameters needed will be explained in detail in the following sections.

SHADOW has two ways of defining the exact figure. One is calculated internally (internal) and the other is user specified (external). In the internal mode, SHADOW computes the mirror parameters for best imaging from point to point. In the default case the focii are located at the CP, but the user can override this by specifying other values as illustrated below. The second way, external, is user specified; the user can enter the radius of a spherical mirror for example.

### 3.1.1 Mirror Surface

PROMPT:

Lets define the mirror. I may compute its parameters, like the radius or the axes. This will not affect the rest of the calculations; all the geometrical parameters may be modified later. Or, you may wish to specify the mirror parameters yourself.

What kind of surface are we dealing with ?

```
spherical      = 1
elliptical    = 2
toroidal      = 3
paraboloid    = 4
plane         = 5
Codling slit  = 6
hyperbolical  = 7
cone          = 8
polynomial    = 9
```

Mirror surface [ 1-9] ? 2

MENU:

```
MAIN MENU                               Optical Element  1

Files to write out                       ALL
Source plane distance                    2000.0000000000E+00
Image plane distance                     500.0000000000E+00
Incidence angle                          88.0000000000E+00
Reflection angle                         88.0000000000E+00
Mirror Orientation Angle                  0.0000000000E+00
Source file                               BEGIN

Type of element (+)                      REFLECTOR
Figure (+)                               ELLIPTICAL
Diffraction (+)                          MIRROR
Crystal (+)                              NO
Mirror movement (+)                      NO
Ripple Surface (+)                       NO
Exit Slit (+)                            NO
Source Movement (+)                      NO
Goto OE (+)
```

SHADOW allows for a variety of basic figures. The standard options are spherical, elliptical, toroidal, parabolical, plane, codling slit, hyperbolic, conical and polynomial. These can then be combined with cylindrical effects, finite dimensions, grating surfaces etc, to define a specific element.

One of the following surfaces must be chosen:

- **spherical:** a section of a sphere. The radius of the sphere can be user specified or calculated by SHADOW using the Rowland circle condition.
- **elliptical:** the surface of revolution described by an ellipse with parameters computed by SHADOW if desired, otherwise with user-specified *major axis*, *minor axis*, and *angle*, in degrees, of the major axis from the x axis measured counter-clockwise. Since SHADOW doesn't know where the pole is located along the ellipsoid (there are infinite possible *positions* of the ellipsoid) we use the angle  $\delta$  to specify it. See figure 3.1 for help determining the angle needed. The major axis must be greater than the minor axis.

p = source distance  
q = image distance  
 $\delta$  = angle

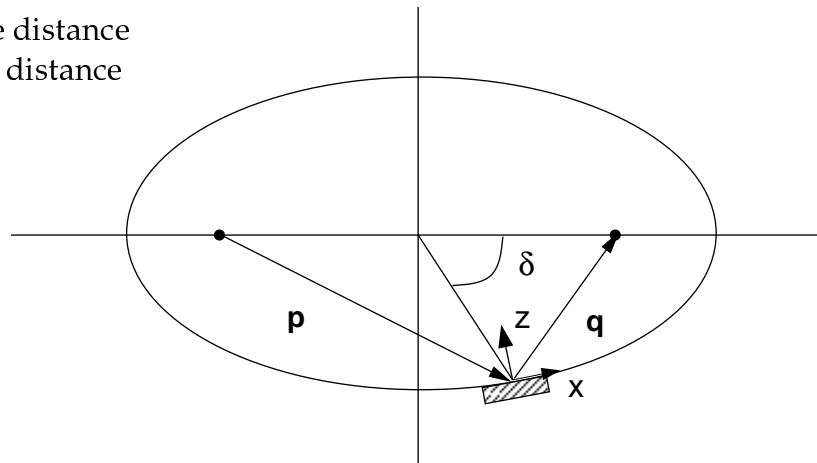

Figure 3.1: User specified Elliptical surface

- **toroidal:** one of the following sections of a toroid:
 

Lower/Outer	Concave/Concave
Lower/Inner	Concave/Convex
Upper/Inner	Convex/Concave
Upper/Outer	Convex/Convex

with Upper and Lower denoting the major radius, Inner and Outer denoting the minor radius (see figure 3.2). If the user wishes to specify the mirror parameters, the major radius and minor radius are required.

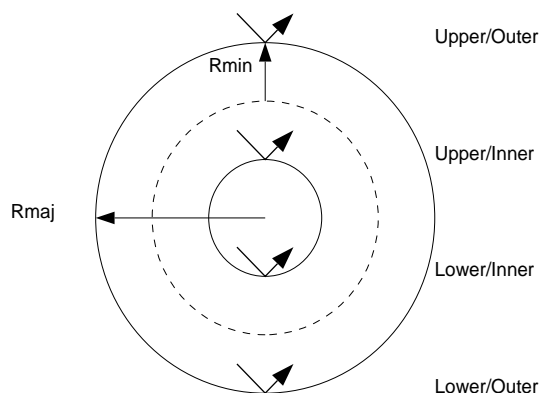

Figure 3.2: Options for toroidal surface

- **parabolical:** the surface generated by rotating a parabola of the form  $ax^2 + bx + c$  about the z axis. The user must specify whether the mirror has its focus at the image (focussing case) or at the source (collimating case). If the user is specifying the mirror parameters, SHADOW needs  $p$  where:  $y^2 = 2px$ .
- **plane:** what one would expect, a flat surface.
- **codling slit:** a slit made by the combination of a slit jaw and a plane mirror acting as the opposing slit jaw, shown in figure 3.3. The effective width of the slit is twice the distance between the slit jaw and the mirror. It does not focus the rays but merely acts as a slit and changes the direction of the beam. As with any slit specification, the user must provide slit width and length.
- **hyperbolic:** the surface of revolution of a hyperbola. To specify the parameters, the user needs the major axis, minor axis and angle of the major axis from the x-axis measured counter-clockwise.



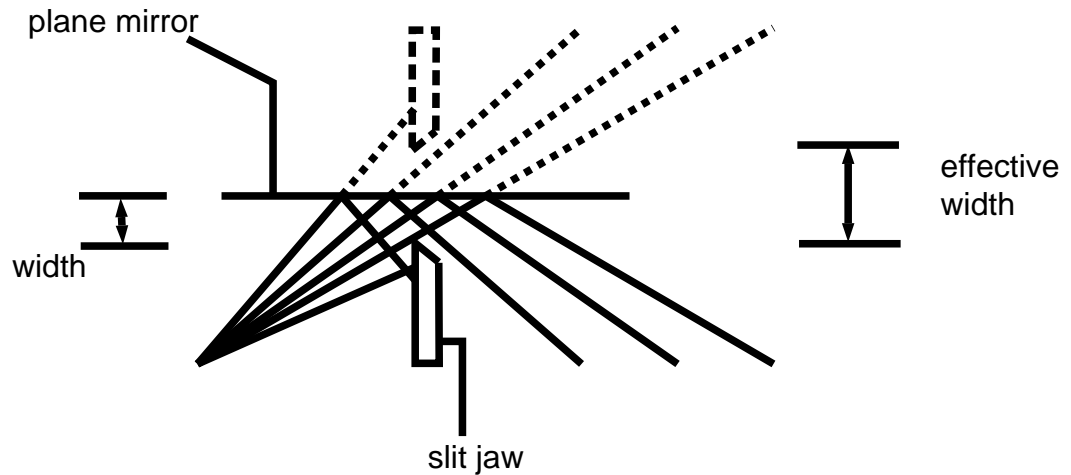

Figure 3.3: Codling slit

- **conical:** the surface representing the interior or exterior surface of a cone. The user may specify the half aperture in degrees if desired.
- **polynomial:** a user defined surface. Typically not one of the above cases. Either a polynomial or a spline surface can be used; the coefficients are read from a file.

---

**Example:**

### 3.2 Options for standard figures

This section will describe ways to modify the perfect three dimensional surface described above. Often, we need to use cylindrical optics (as those formed by bending a flat surface) and/or convex surfaces. We need a way to specify these cases.

### 3.2.1 Cylindrical Mirror

PROMPT:

```
Mirror surface [ 1-9] ? 1
Do you want to specify the mirror parameters ? 0
Is the mirror Cylindrical ? 1
Angle of cylinder axis from x axis [ 0 ] ? 0
```

MENU:

```
OE specifications                               Optical Element  1
Mirror parameters (+)                           INTERNAL
Surface curvature                              CONCAVE
Cylindrical                                     YES
orient. [ CCW from X axis ]                   0.0000000000000E+00
Reflectivity (+)                               OFF
Limits check (+)                              NO
```

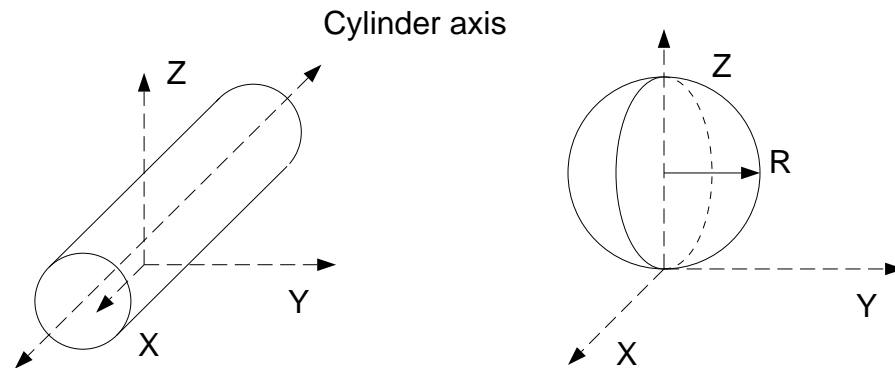

Figure 3.4: Cylindrical element

The default for the cylindrical option is “OFF” – SHADOW uses the full figure for the calculations. If desired, a cylindrical element can be used to focus in only one direction.

SHADOW forms the element in the following way. The intersection of the fill surface and a specified plane (by default the  $X$ - $Z$  plane) is found. The two dimensional curve that forms that intersection is extruded perpendicular to the plane to form a cylindrical object with a cross section of the two dimensional curve. For example, if the user chooses “SPHERICAL”, the resulting element is similar to a can, shown in Figure 3.4.

By default, the cylinder axis is coincident with the element  $X$ -axis (*zero degrees rotation*) corresponding to tangential focussing. SHADOW allows the user to choose any angle of rotation for the plane used in the intersection. The angle between the cylinder axis and the  $X$ -axis is specified counter-clock-wise (CCW), in degrees.

---

**Example:**

Cylindrical mirrors are used in situations where focusing is desired in one direction only. They are also useful in combination with other mirrors when the three dimensional figure is very complex or impossible. A typical case is that of the Kirkpatrick-Baez optics, where two glancing, cylindrical mirrors are used to focus in both directions.

### 3.2.2 Convex/Concave Option

PROMPT:

```
Is the mirror convex [ Y/N ] ? 0
```

MENU:

```
OE specifications                               Optical Element  1
Mirror parameters (+)                          INTERNAL
Surface curvature                             CONCAVE
Cylindrical                                   NO
orient. [ CCW from X axis ]                   n/a 0.0000000000000E+00
Reflectivity (+)                              OFF
Limits check (+)                              NO
```

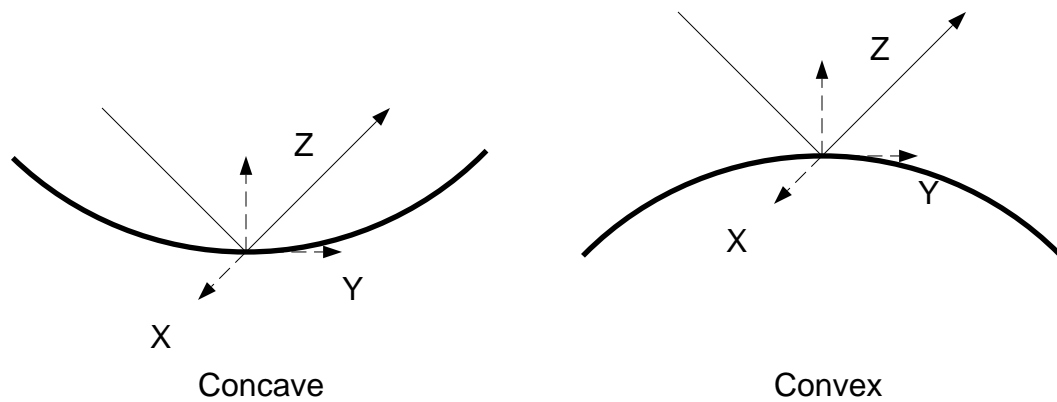

Figure 3.5: Concave and convex element surfaces

SHADOW is asking whether you want a convex or concave reflecting surface. The “NO” answer in PROMPT is the default in MENU mode – CONCAVE (figure 3.5). For instance, a normal lens maybe convex on one side and concave on the other.

---

### 3.2.3 Mirror Dimensions

PROMPT:

```
Mirror Dimensions finite [ Y/N ] ?1
Mirror shape. Options:
    rectangular :    1
    full elliptical :  2
    "hole" elliptical : 3
Shape: [ 1, 2, 3 ] ?1
Mirror half-width x(+) ? 2.5
Mirror half-width x(-) ? 2.5
Mirror half-length y(+) ? 4.75
Mirror half-length y(-) ? 4.75
```

MENU:

```
Mirror Shape                                Optical Element 1
Shape selected                               RECTANGLE          d
Mirror dimensions along axis:
use ABSOLUTE values.
rectangle / ellipse
X(+) Half Width / Int Maj Ax                2.500000000000
X(-)              / Ext Maj Ax                2.500000000000
Y(+)              / Int Min Ax                4.750000000000
Y(-)              / Ext Min Ax                4.750000000000
```

Use RECTANGLE ELLIPSE HOLE (Return)

---

If mirror dimensions option “*not finite*” is chosen, the mirror dimensions are considered large enough as not to limit the transmission of the rays (providing there is a real solution to the intercept of the ray and the element figure). If you choose instead “*finite mirror dimensions*” rays that fall outside the limits will be considered lost; while they will be traced through the rest of the system their flag will be set to (element number)\*(-11000). A further loss will reset this flag so the ray will carry the label of the *most recent loss*. A “hard loss” – i.e., an imaginary intercept – will of course not be traced further. Notice that the use of this flag allows the tracing of scattered light through the system. In MENU mode this is called LIMITS CHECK in the sub-menu under FIGURE. To choose finite dimensions, enter ON for LIMITS CHECK and enter its sub-menu to specify the shape and dimensions. Allowable shapes are RECTANGLE, ELLIPSE and ELLIPSE W/HOLE. Sizes are specified in the length units used so far.

---

**Example:**

In an optical system, vignetting occurs when the beam overfills the mirror (or lens). It is important to verify that this does not occur in systems where parameters may change (i.e., diffraction gratings).

### 3.2.4 Distorted Surface

PROMPT:

```

Distorted surface [ Y/N ] ? 1
Sinusoidal ripple (0)
Gaussian ripple (1)
External spline (2)
Type of distortion ? 0
Wavelength along the X-axis ?
.025
                and the Y-axis ?
30
Amplitude along the X-axis ?
.001
                and the Y-axis ?
.01
Phase for X-axis. 0 means a maximum at the origin. Then ?
0
and for Y-axis ?
0

```

MENU:

```

Surface Quality                               Optical Element 1
Type of defect                                SINE
File-name                                     n/a NONE SPECIFIED
Ripple Wavel. X                               0.250000000000000E-01
                Y                               30.0000000000000
Ampli. X                                       0.100000000000000E-02
                Y                               0.100000000000000E-01
Phase X                                        0.0
                Y                               0.0

```

Use SINE GAUSSIAN SPLINE (Return)



The “*distorted surface*” option in SHADOW will add an error surface to the already specified shape. Essentially, SHADOW will solve the equation:

$$Z(x, y) = Z_0(x, y) + \Delta(x, y)$$

where  $Z_0$  is the ideal surface,  $\Delta$  is the error defined as the *local* difference between the ideal and real surface. The distortion can be a *sinusoidal ripple*, a *gaussian error* or an externally defined, completely general *spline* surface. Notice that all these errors are treated in a *deterministic* and *geometrical optics* framework. The *sinusoidal* ripple requires the input of the ripple wavelength along  $X$ , the wavelength along  $Y$ , the amplitude in both  $X$  and  $Y$ , the phase of the sine wave on the  $X$ -axis, and the phase on the  $Y$ -axis. The *gaussian* option requires the input of a file containing the parameters of the gaussian functions. The external spline requires an input file created with the utility PRESURFACE. The file contains a bi-cubic spline representing the error surface, obtained by a fit to a user specified error surface. The user creates a surface mesh array in the form of:

```

Nx, Ny
Y(1), . . . , Y(Ny)
X(1), Z(1,1), . . . , Z(1,Ny)
:
X(Nx), Z(Nx,1), . . . , Z(Nx, Ny)

```

where  $N_x$  and  $N_y$  are the size of the surface mesh. PRESURFACE reads the file and computes the appropriate output for SHADOW. For more information on the file, consult the User’s Guide on the Utilities.

---

**Example:**

Distortions can occur as a result of machining, heat loading, contamination, etc. If the surface errors can be mapped, SHADOW can add the information to the ideal surface giving the user a more realistic picture of the image.

### 3.2.5 Surface Roughness

PROMPT:

```
Do you want to include surface roughness [Y/N] ? Y
File to read ? PSINFO
Roughness RMS in Y direction (along the mirror) [Angstroms] ? 10
Roughness RMS in X direction (transversal direction) [Angstroms] ? 10
```

MENU:

```
Scattering                               Optical Element 1

Surface Roughness                        r/o YES
File w/ power spec. dens. fn.           PSINFO
Roughness RMS in Y (Angstroms)          10.0
Roughness RMS in X (Angstroms)          10.0
```

Surface roughness is defined as irregularities in the optical surface which produce dispersion (scattering) of the incident radiation rather than reflection. This is treated as a *stochastic* process than *deterministic*. In this framework we consider the high-frequency component of the error function  $\Delta$ . We can imagine the surface as the sum of many small random (in pitch, amplitude and orientation) diffraction gratings. The ray striking at location  $\{x_0, y_0\}$  will have a probability  $P_0$  of being elastically reflected and  $P_s$  of being scattered,  $P_s$  being proportional to the amplitude of the roughness. SHADOW uses the RMS roughness in X and Y and a file containing the normalized power spectral density function (PSD) to simulate the surface scattering. The input file can be generated with the *jntpscale* utility to create a number of different distributions or the file can be created by the user in the correct format. The distributions available in *jntpscale* are a gaussian power spectrum, a PSD from a profile with normal statistics and a gaussian correlation function, a PSD from a profile with normal statistics and an exponential correlation function, and a PSD along Y from a data file and gaussian along X. The input file to SHADOW is written with a FORTRAN program and has the following format:

```

Number_Points_in_X
X_Starting_Point
X_Step_Size
Number_Points_in_Y
Y_Starting_Point
Y_Step_Size
((Power_Spectral_Density_Function(i,j), i=1,NX) j=1,NY )

```

The *surface roughness* is located under the “Modified Surface” menu in MENU mode. SHADOW determines the probability of a ray being scattered or specularly reflected. For those rays being scattered, the PSD is used as a probability distribution function to find the ruling of the “grating” created by the surface roughness.

---

**Example:**

If we create a PSD using *jntpscale* for a gaussian power spectrum and apply it to an elliptical mirror we can see how the image of the point source degrades. The parameters used in *jntpscale* are 100 points in each Y and X, start and end values of 0 and 1000 respectively, sigma of  $100 \text{ cm}^{-1}$  and a center at (0,0). We have defined a point source with a uniform divergence of  $\pm 0.5$  mrad in the horizontal and  $\pm 0.05$  mrad in the vertical. It has a single energy of 8035 eV. The mirror is elliptical with the source at 30 meters, image at 10 meters and incidence angle of 88.5 degrees. The resulting plot is shown in figure 3.6.

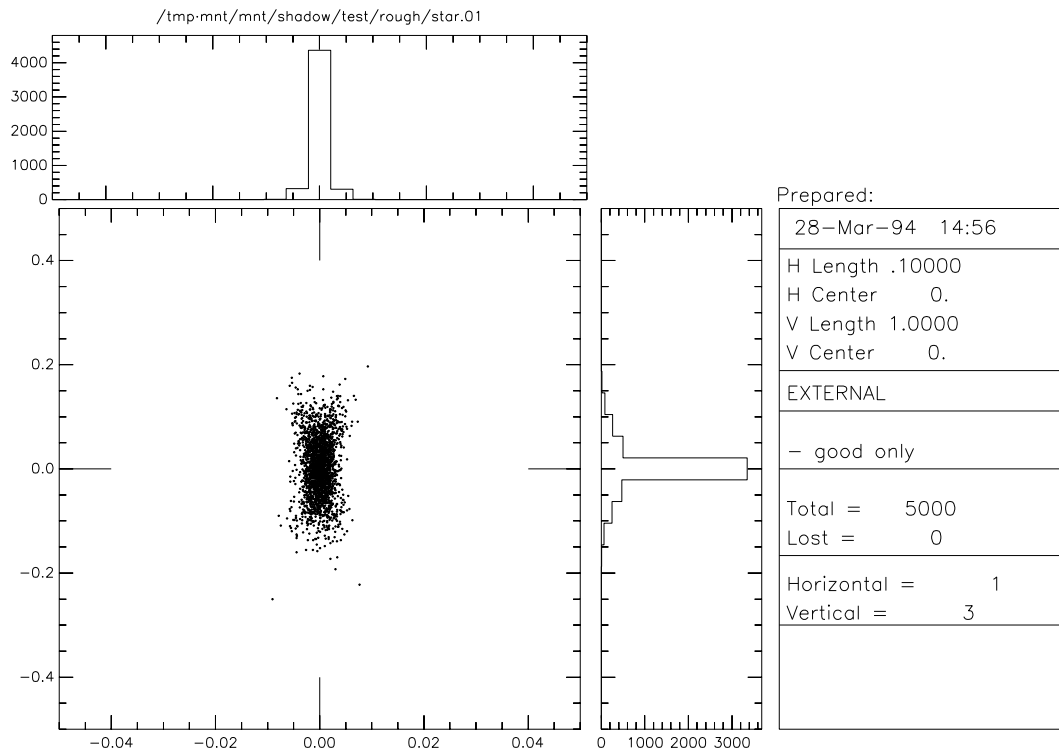

Figure 3.6: Image after applying surface roughness to elliptical mirror

## **Chapter 4**

# **Object Types**

Independent from the surface figure, is the type of object that is interacting with the light. The different objects: mirror, lens, grating, crystal, compound mirrors, capillaries, Fresnel zone plates, and screens are all specified slightly differently.

## 4.1 Mirror

PROMPT:

```
Optical Element definition:
Incidence Angle ? 88
Source Distance ? 2000
Reflection Angle? 88
Image Distance ? 500
Reflector [ 0 ] or refractor [ 1 ] ? 0
```

MENU:

```
MAIN MENU                                Optical Element 1

Files to write out                        ALL
Source plane distance                     2000.000000000000E+00
Image plane distance                      500.000000000000E+00
Incidence angle                           88.000000000000E+00
Reflection angle                          88.000000000000E+00
Mirror Orientation Angle                   0.000000000000E+00
Source file                               BEGIN

Type of element (+)                       REFLECTOR
Figure (+)                                PLANE
Diffraction (+)                           MIRROR
Crystal (+)                               NO
Mirror movement (+)                       NO
Ripple Surface (+)                        NO
Exit Slit (+)                             NO
Source Movement (+)                       NO
  Goto OE (+)
```

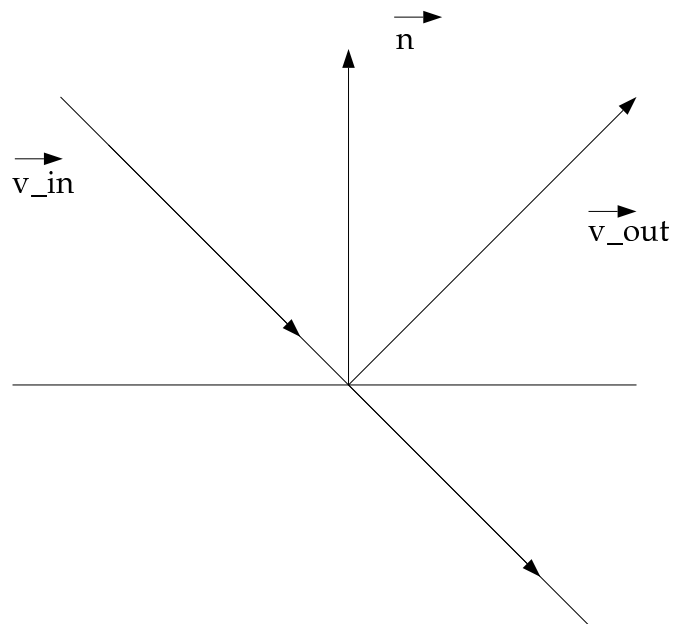

Figure 4.1: Mirror reflection

A mirror is specified by choosing a *reflecting* optical surface, i.e., one where

$$(\vec{V}_{out} - \vec{V}_{in}) \bullet \vec{n} \geq 0$$

as shown in figure 4.1. All other information about the mirror is included in the surface section and the optical properties section.

Note: Other types of elements will also be based on reflectors. Gratings, Bragg crystals, compound mirrors and capillaries all need the reflector option.

---

**Example:** A point source is reflected at grazing incidence off a plane mirror. The system plot is shown in figure 4.2.

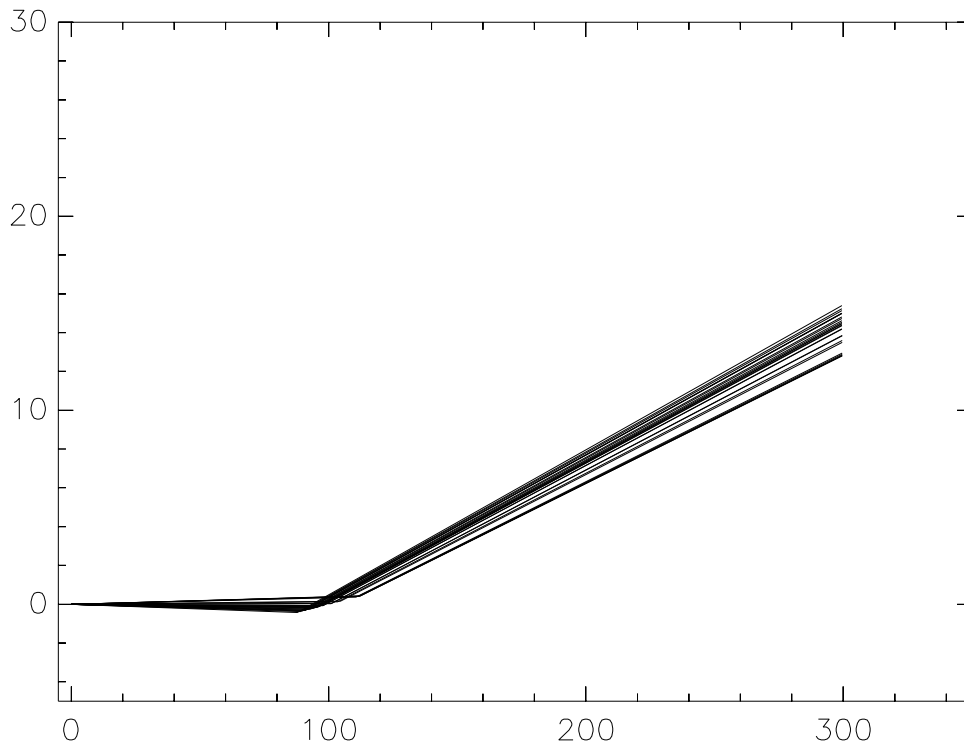

Figure 4.2: Side view of a reflecting optical system.



## 4.2 Lens

PROMPT:

```
Optical Element definition:
Incidence Angle ? 0
Source Distance ? 1000
Reflection Angle? 180
Image Distance ? 1
Reflector [ 0 ] or refractor [ 1 ] ? 1
```

MENU:

MAIN MENU	Optical Element 1
Files to write out	ALL
Source plane distance	1000.000000000000E+00
Image plane distance	1.00000000000000E+00
Incidence angle	0.00000000000000E+00
Reflection angle	1800000000000000E+00
Mirror Orientation Angle	0.00000000000000E+00
Source file	BEGIN
Type of element (+)	REFRACTOR
Figure (+)	SPHERICAL
Diffraction (+)	MIRROR
Crystal (+)	NO
Mirror movement (+)	NO
Ripple Surface (+)	NO
Exit Slit (+)	NO
Source Movement (+)	NO
Goto OE (+)	

Element	Source Distance	Image Distance	Inc. Angle	Refl. Angle	Refr. Index Object	Refr. Index Image	Spherical Radius	Concave/Convex
1	1000	1	0	180	1.0	1.5	1000	Convex
2	4	1000	0	180	1.5	1.0	1500	Concave

Table 4.1: System parameters for Lens example

If a refractor is chosen, the refractive index in both image and object space must be provided. The SHADOW convention defines an element as a single instance of light/surface interaction. (The capillary is an exception). Therefore choosing a refractive surface only specifies one change in medium. For standard lens situations, it will take two elements to define the lens. No approximation (thin lens, etc.) is made – the rays are traced exactly.

---

**Example:** A sample lens is created and traced. The system information and plot are shown in the table and figure below.

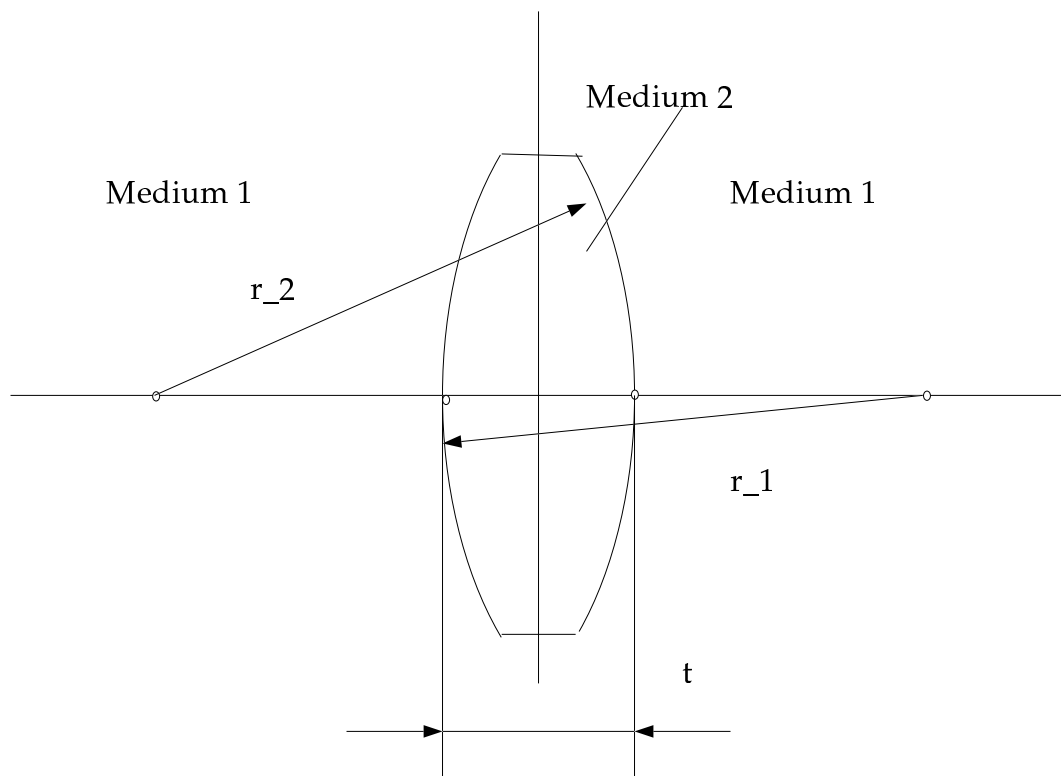

Figure 4.3: Lens description

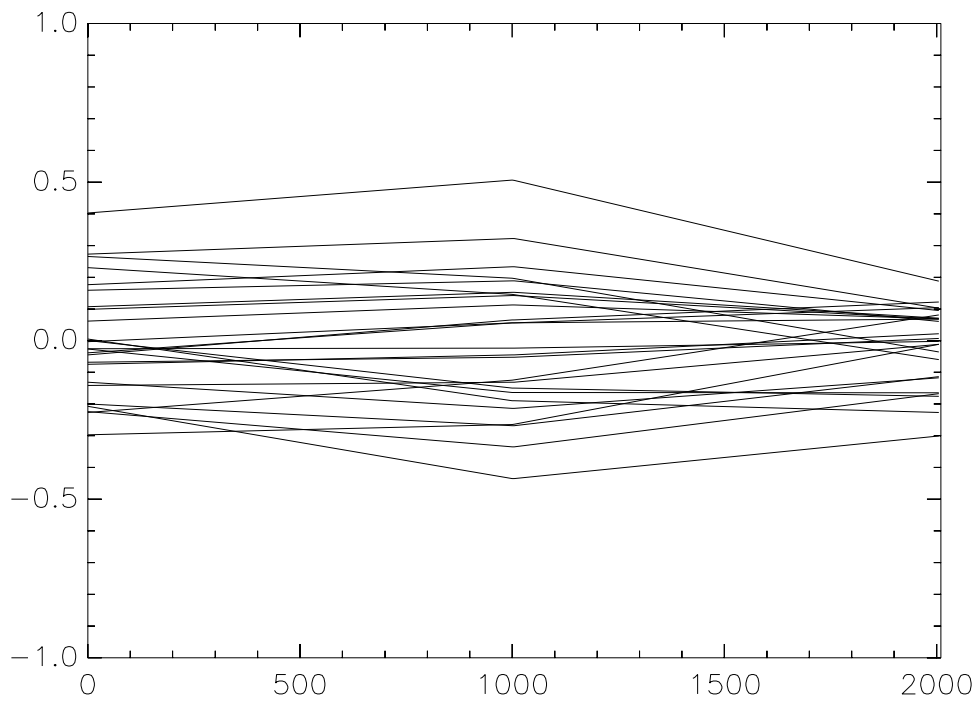

Figure 4.4: Side view of a refracting optical system.

## 4.3 Gratings

PROMPT:

```

Are we dealing with a Grating ? 1

Type of ruling.
0  ruling density constant on the X-Y plane
1  for ruling density constant onto the mirror surface.
2  for an holographic grating.
3  for an oriental-fan type
4  reserved
5  polynomial line density
Then: 2
Hologram Recording Parameters.
The angles are positive if the source is on the side of the Y-axis.
"EnS" means Entrance Slit Side Source
"Rotation" refers to rotation around Z
Distances [ cm! ] and angles [ degrees ] refer to hologram.
EnS distance: 919.3
EnS incidence angle: 10.36
EnS rotation angle: 0
ExS distance: 619
ExS incidence angle: -12.81
ExS rotation angle: 0
Recording Wavelength [ Angs ] ? 4879.86
Type of recording sources. We have the choices:
Both    SPHERICAL                0
Source  PLANE,    image SPHERICAL  1
Source  SPHERICAL, image PLANE     2
Source  PLANE,    image PLANE     3
Source type [ 0-3 ]. Then ? 0
The SPHERICAL source can also be specified to be CYLINDRICAL, with axis
perpendicular to recording plane.
Use:
None    Cylindrical                0
Source  Cylindrical, image Spherical  1
Source  Spherical,    image Cylindrical  2
Both    Cylindrical                3
Cylindrical [ 0-3 ] ? 0

```

MENU:

```

Define grating                                Optical Element 1

Ruling type (+)                               HOLOG
Grooves Pole distance                         n/a 0.000000000000000E+00
      azimuth                                 n/a 0.000000000000000E+00
Coma correction factor                       n/a 0.000000000000000E+00
Lines/CM (at origin)                         n/a 12000.00000000
Polynomial line density coeff:
  linear                                       n/a 0.000000000000000E+00
  quadratic                                   n/a 0.000000000000000E+00
  third power                                 n/a 0.000000000000000E+00
  fourth power                                n/a 0.000000000000000E+00
Signed/Absolute                              n/a ABSOLUTE
Auto tuning                                  YES
Diffraction order                            -1.000000000000
Energy/wavelength                             EV
      at Angs.                               n/a 5000.000000000
      at eV.                                  59.000000000000
Mount type (+)                                TGM

```

The analysis of diffraction gratings is one of the central applications of SHADOW. Optically speaking, a diffraction grating can be considered as a particular case of roughness – deterministic and (hopefully) exactly predictable. In SHADOW, gratings are modeled by superposing a ruling pattern to a (possibly) shaped surface. In general, the diffraction from the grating depends on the *local* line spacing and their orientation. Let  $\vec{\xi}$  be the vector *tangent* to the surface and *orthogonal* to the grooves. Hence the new ray is provided by the Bragg condition:

$$\vec{\phi}_{out,\parallel} = \vec{\phi}_{in,\parallel} + m \bullet \frac{2\pi}{d} \vec{\xi}$$

where

$$|\vec{\phi}_{out,\parallel}| = |\vec{\phi}_{in,\parallel}| = \frac{2\pi}{\lambda}$$

and  $\vec{\phi}_{out,\parallel}$  is the component of the wavevector in the surface tangent plane. The ruling can be one of the following types: *constant on the basal plane*, *constant on the surface*, *holographically recorded*, an “*oriental fan*” type, or a *polynomial spacing*. The ruling density is specified in lines/cm, the diffraction order is given following the European convention of negative orders inside. Additionally, SHADOW can “autotune” the grating to a specified energy or wavelength. The user chooses the energy and the type of grating mount. SHADOW then rotates or rotates and translates the grating so the desired energy illuminates the image plane.

The following information needs to be provided for the various cases:

- Constant ruling types – ruling density in lines/cm at the origin.
- Holographic gratings: distance (cm), incidence angle and rotation angle of the entrance slit side source and exit slit side source (degrees), recording wavelength (Angstroms), type of recording source – spherical or plane and if spherical, spherical or cylindrical, real or virtual sources.
- Oriental fan type: the location of the ruling focus on the mirror plane by the angle from the Y axis in degrees, measured counter-clockwise (CCW), the distance from the grating center in cm, the coma correction factor and the line density at the grating center.
- Polynomial line spacing: coefficients of the polynomial –  $a_0$ ,  $a_1$ ,  $a_2$ ,  $a_3$  and  $a_4$ ,

$$R(y) = a_0 + a_1y + a_2y^2 + a_3y^3 + a_4y^4$$

where  $a_0$  is the ruling density at the origin, and whether the polynomial is signed or absolute.

## PROMPT:

```

Sources REAL/ VIRTUAL:
EnS real,   ExS real  0
EnS real,   ExS virtual:  1
EnS virtual, ExS real:    2
EnS virtual, ExS virtual  3
Then ? 0

We follow the European convention. NEGATIVE orders are inside.
Diffraction Order ? -1
Enter 1 if you want me to position the grating at the correct
wavelength, 0 to leave everything as it is.
Auto Tuning of Grating [ Y/N ] ? 1
You must then supply the wavelength (or photon energy)
which you want the grating tuned.
Energy, in eV, [ 0 ] or wavelength, in Angs., [ 1 ] ? 0
Photon Energy ? 59
SHADOW recognizes several types of Grating mounts and/or monochromators.
We have several choices, depending on what kind of mount you
are using. They are :
  TGM/SEYA mount (constant included angle)
  In this case the source/image distances are not changed from
  the one already specified and the grating is rotated to match
  the diffraction conditions.
  ERG/GRASSHOPPER (constant incidence angle)
  plane is positioned on the Rowland circle at the appropriate diffraction angle.
  CONSTANT INCIDENCE ANGLE and image plane at the
  position already specified. Only the diffraction angle is modified.
  CONSTANT DIFFRACTION ANGLE. The incidence angle
  is modified to match the diffraction conditions. The planes are not moved.
  for a CONSTANT BLAZE mount (Hunter type)
TGM/SEYA    0
ERG         1
Con Inc Ang 2
Con Dif Ang 3
Hunter      4
Mount type ? 0

```

## MENU:

```

Define hologram                               Optical Element 1

"left" distance (cm)                          919.3000000000
        incidence angle                       10.360000000000
        azimuth from +Y [CCW]                 0.000000000000E+00
"right" distance (cm)                         619.0000000000
        incidence angle                       -12.810000000000
        azimuth from +Y [CCW]                 0.000000000000E+00
SP = spherical, PL = plane
Pattern type                                 SPSP
V = virtual, R = real
Source type                                  R/R
SP = spherical, CL = cylinder
Cylindrical source                           SPSP
Recording wavelength (Angs.)                 4879.8600000000

```

**Example:** The example enters the parameters of the Six meter TGM grating for medium energies. The ruling on the grating is holographic and is specified by recreating the hologram for SHADOW. We have used two spherical, real sources. The grating is being tuned to 59 eV using a constant included angle mount (TGM/SEYA).

---



## 4.4 Crystals

PROMPT:

```

Are we dealing with a crystal [ Y/N ] ? 1
File containing crystal parameters ?
SI.PAR
Is it a mosaic crystal [ Y/N ] ? 0
Is the crystal asymmetric [ Y/N ] ? 1
Enter the angle formed by the crystal planes with the crystal surface. Use a
positive value if the plane normal lies along the +Y direction (focusing),
negative otherwise.
Planes angle [ deg ] ? 7
Are we working in Johansson geometry [Y/N] ? 0
Automatic Tuning of Crystal [ Y/N ] ? 1
You must then supply the wavelength (or photon energy) at
which you want the crystal tuned.
Energy, in eV, [ 0 ] or wavelength, in Angs., [ 1 ] ? 0
Photon Energy ? 7750

```

MENU:

Crystal Specifications	Optical Element 1
File with crystal parameters	SI.PAR
Reflectivity mode	OFF
Auto setting	YES
Units in use	EV
Set photon energy	7750.000000000
wavelength	n/a 5000.000000000
Asymmetric cut	YES
Johansson Geometry	NO
Mosaic crystal	NO
Planes angle [ deg ]	7.0000000000000
Johansson Radius	n/a 0.0000000000000E+00
Angle spread FWHM [ deg ]	n/a 0.0000000000000E+00
Thickness [ cm ]	n/a 0.0000000000000E+00
Seed for mosaic [ > 10^5 ]	n/a 1626261131

SHADOW has the capability of running crystals as optical elements. SHADOW deals with crystals in both reflection (Bragg) and transmission (Laue) mounting. Two crystal models are allowed in

**SHADOW:** perfect crystals (i.e. Silicon, Diamond) and mosaic crystals, where the crystal block is made by an agglutination of small microcrystals (i.e. graphite, beryllium). Perfect crystals may be symmetric (the Bragg planes are parallel to the crystal surface in Bragg mounting, and perpendicular in Laue mounting) and asymmetric, when the crystal planes form an arbitrary angle  $\alpha$  with the crystal surface. Mosaic crystals can only be symmetrical in SHADOW. Ground-bent crystals (the so-called Johansson geometry) for perfect crystals are also allowed in SHADOW.

For all crystal modes, and input file, created by the utility BRAGG is needed. The file contains the optical constants information for a given crystal in a specified energy range. See the Utilities manual (or the SHADOW Primer) for more information on running BRAGG. Other information the user may need to supply is:

**Asymmetric:** angle between the cut and the crystal planes (degrees).

**Johansson:** radius of curvature (length units).

**Mosaic:** the angle spread (FWHM) in degrees, thickness (cm) and a seed for the random number generator.

SHADOW offers to tune the crystal to a specific energy or wavelength if desired. The program will calculate the correct incidence angle for a given energy and override user inputs if the autotune option is chosen.

---

**Example:**

## 4.5 Compound Mirrors

PROMPT:

```

Compound mirrors ( or lenses) are formed
by several smaller mirrors ( facets) combined together.
A: Is this mirror faceted [Y/N] ?1
B: File with the polynomial describing the facet?facet.dat
We need to define which side of the surface
to use (see demo for further explanation).
    3      closest
    2      ...
    1      ...
    4      farthest
Choice[1-4]?3
Size of the Facet?
  x-length ?5
  y-length ?5
Choose the baseline for facet

```

MENU:

```

Faceted Mirror                                Optical Element 1

Facets selection                               r/o YES
File w/ facet descr.                          facet.dat
Lattice type                                  RECTANGLE
Orientation                                    Y-AXIS
Intercept to use                              FARTHEST
In X-direction -----
Number of facets                              11
Facet width                                  5.000000000000
  phase (0-360)                               0.
Dead width (abs, for -X)                      0.
  (abs, for +X)                              0.
In Y-direction -----
Number of facets                              11
Facet width (in Y)                            5.000000000000
  phase (0-360)                               0.
Dead width (abs, for -Y)                      0.
  (abs, for +Y)                              0.

```

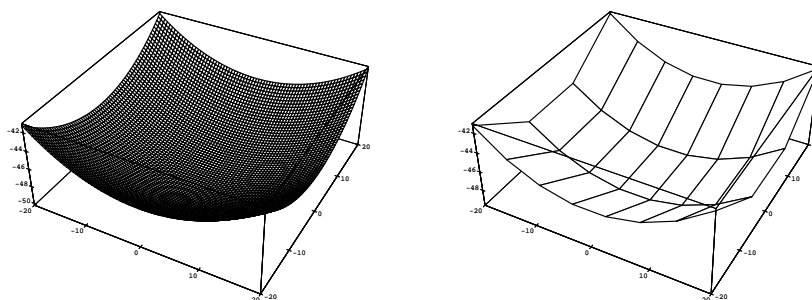

Figure 4.5: Smooth (traditional) mirror left, faceted case right.

A compound mirror is constructed of a figured baseline that is covered with an array of small mirrors each with a possibly independent figure (see Fig. 4.5). The baseline must be a continuous figure; if it is not, it would fall into the case of segmented mirrors. The baseline surface is defined in SHADOW as a normal mirror would be, with its normal along the local  $Z$  axis. The projection of this figure onto the  $X - Y$  plane is divided into an array of projections of the facets. The intercept with the baseline surface is calculated and used to determine which facet will be hit. The algorithm is similar to the capillary case. The normal of the facet is assumed to be aligned with the local normal to the baseline surface, the orientation of the facet is defined by its tangent and binormal vectors as is done in the standard case. The ray is transformed into the facet reference frame. The intercept and reflection are calculated, and the ray returned to the baseline reference frame.

The input required is:

- a file containing the polynomial describing the facets. The file format, shown in table 4.2, contains the degree of the polynomial and a representation of the coefficients.
- the size of the facets (length units).
- which intercept of the facet surface to use (CLOSEST, NEXT CLOSEST, NEXT FARTHEST, FARTHEST). A polynomial of a given degree will usually create that many solutions. In normal surfaces, SHADOW usually uses the farthest intercept.

first line	order of polynomial	4
2 . . . n	$x^a \cdot y^b \cdot z^c = d$	a b c d
last line	end of file	-1

Table 4.2: File format for compound mirrors

Plane facet example	Toroidal facet example
1	4
0 0 1 1	2 0 0 184806921.4254561
0 0 0 0	4 0 0 1.
-1	0 2 0 728306.48344865400
	2 2 0 2.
	0 4 0 1.
	0 0 1 9920435542.118486
	2 0 1 27242.4748840000
	0 2 1 27242.4748840000
	0 0 2 186266415.9348293
	2 0 2 2.
	0 2 2 2.
	0 0 3 27027.754884000
	0 0 4 1.0
	-1

Table 4.3: Input file for SHADOW for various facet shapes

---

**Example:** An x-ray lithography beamline designed to create a smooth, scannable image uses two toroidal mirrors. Example input files for SHADOW are in Table 4.3. We place planar facets of decreasing size on the mirrors and watch as the image approaches ideal. (see Figure 4.6).

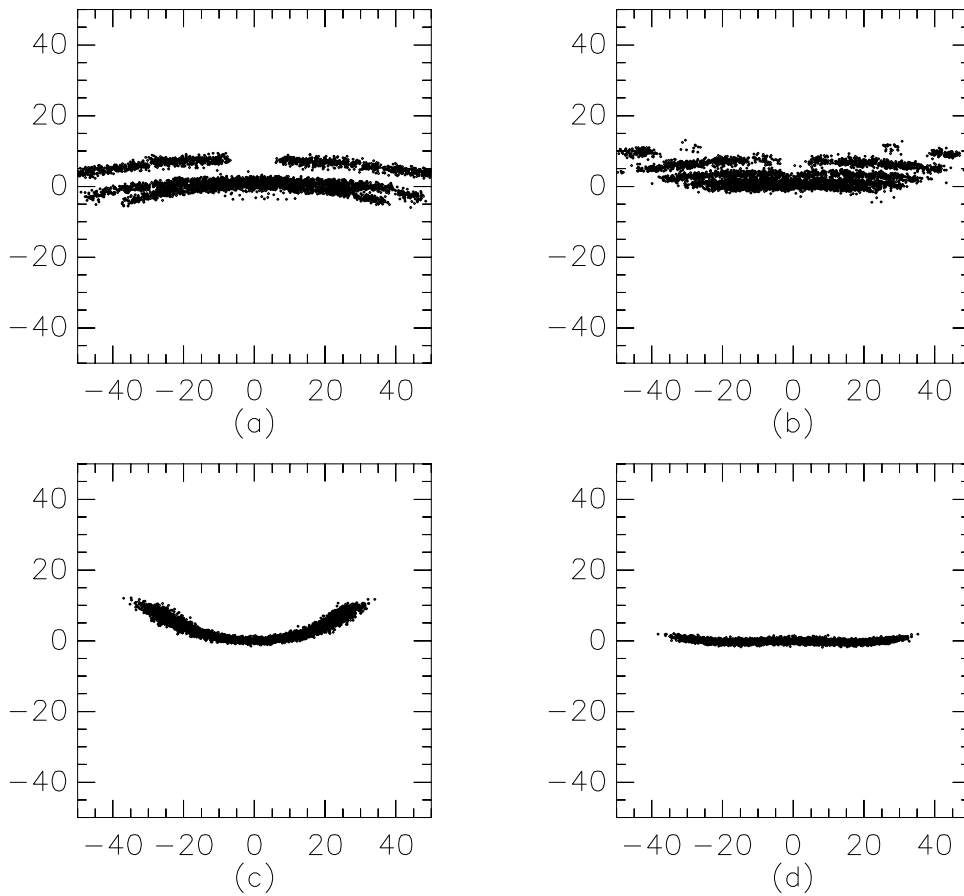

Figure 4.6: Final image of x-ray lithography beamline. a.) 10mm x 20mm facets, b.) 5mm x 10mm facets, c.) 0.01mm x 0.1mm facets, and d.) smooth mirrors.

## 4.6 Capillaries and Kumakhov Lenses

PROMPT:

```

Kumakhov lens are formed from tube arrays
their packing pattern are Wigner-Seitz type cell.
A capillary would be the central tube of a kumakhov lens.
Is this a Kumakhov system?1
For multiple reflection calculations, you may
want to store the intercepts of each bounce.
Store (X,Y,Z) for each bounce? 0
Normally, the tube radii are specified as r(z).
You may also specify r(z)^2.
Specify as r(z)^2 ? (Y/N) 0
File with the parameters?kumal.dat

```

MENU:

```

Kumakhov Lens                                Optical Element 1

Kumakhov lens selection                      r/o YES
Specify r(z)^2 (Y/N)                          NO
File with parameters(r(z))                    kumal.dat
File with parameters(r(z)^2)                  n/a NONE SPECIFIED

Save intercept and bounces                     NO

```

For the majority of optics calculations, a single intercept of a ray with each surface is sufficient. However, for optics constructed of capillaries – single or arrays of thousands – the light must be tracked through multiple bounces from beginning to end. We have added a special type of optic to SHADOW to handle cases where the light is traveling down a tube. The model was constructed with the idea of having an array of tubes, but it has been extensively tested in single capillary cases as well. SHADOW calculates internally the manner in which the tubes are packed together using a simple Wigner-Seitz cell algorithm with the lattice points defined by user-specified basis vectors. This cell arrangement is used to decide which tube the ray will enter. The array of tubes is specified by a family of polynomials that track the centerline and the change in radius. The equations describing the tubes are as follows:

$$(X - C_i g(z))^2 + (Y - C_j g(z))^2 = (r_0 f(z))^2 = R^2 \quad (4.1)$$

$$g(z) = -\frac{z}{S} - \frac{z^2}{2SL} + 1 \quad (4.2)$$

where  $(C_i, C_j)$  are the center coordinates of each tube at the entrance plane of the lens,  $r_0$  is the initial tube radius,  $S$  is the source distance, and  $L$  is the tube length. The function  $g(z)$  specifies how the centerline of the tube is changing, and  $f(z)$  specifies how the radius of each tube is changing. The tube information is passed to SHADOW through a user created file. Using the cell algorithm, SHADOW determines which tube the ray will enter. Each ray is propagated through the tube saving intercept information for each bounce (if desired). Losses to the spaces between the tubes are considered. Additionally, reflectivity calculations are fully implemented for the lens. See the section on adding optical properties for more information.

As input, SHADOW requires a file containing the polynomial describing how the tube directions are changing and how the radii of the tubes are changing. There is also the option to save the intercepts of each bounce made by each ray. The input file should contain the information shown in Table 4.4.  $g(z)$  represents the polynomial along the tube centerlines,  $f(z)$  is the polynomial that tells how the radius of each tube is changing.

The multi-bounce model was constructed with the idea of having an array of tubes, but with appropriate source specification can be used for single capillaries as well. In this case, it may be more convenient to specify the radius of the tube as  $r^2(z)$  instead of  $r(z)$ .  $g(z)$  is zero for this case. At this time, specifying the single tube in this manner limits you to circular cross sections. SHADOW asks if you are going to specify the radii as  $r(z)$  or  $r^2(z)$ . In the second case the input file looks like the example in Table 4.5.

Watch your signs on the polynomial coefficients.

$$R^2(x, y) - r^2(z) = 0$$



Example Input file	What the values represent
0.028	Two dimensional basis vectors a_1
0.	a_2
0.014	b_1
0.02424871130596428	b_2
200.	tube length (mm)
-0.03333333	polynomial coefficients for $g(z)$ a_g
-0.00008333333333	where $g(z) = az + bz^2 + 1$ b_g
0.033	initial tube radius (mm)
-0.03333333	polynomial coefficients for $f(z)$ a_f
-0.00008333333333	where $f(z) = az + bz^2 + 1$ b_f
4	square of degree of the polynomial $\leq 4$
3	solution of polynomial to use

Table 4.4: Input file for standard capillary calculations.

Example Input file	What the values represent
402.0	basis vectors a_1
0.0	basis vectors a_2
201.0	basis vectors b_1
348.14221232113443	basis vectors b_2
7650	tube length (mm)
400	initial tube radius
-160000.	polynomial coefficients $z^0$
0.0	$z^1$
0.0025	$z^2$
0.0	$z^3$
0.0	$z^4$
2	degree of polynomial $\leq 4$
3	solution of polynomial to use

Table 4.5: Input file for single capillary calculations.

## 4.7 Fresnel Zone Plate

PROMPT:

```

Mirror surface [ 1-9] ? 5
Is the mirror Cylindrical ? 0
Is this optical element a Fresnel Zone Plate ? 1

  For a Fresnel Zone Plate select the appropriate HOLOGRAPHIC case.
Type of ruling.
0  ruling density constant on the X-Y plane
1  for ruling density constant onto the mirror surface.
2  for an holographic grating.
3  for an oriental-fan type
4  reserved
5  polynomial line density
Then: 2
Hologram Recording Parameters.
The angles are positive if the source is on the side of the Y-axis.
"EnS" means Entrance Slit Side Source
"Rotation" refers to rotation around Z
Distances [ cm! ] and angles [ degrees ] refer to hologram.
EnS distance: 10
EnS incidence angle: 0
EnS rotation angle: 0
ExS distance: 10
ExS incidence angle: 180
ExS rotation angle: 0
Recording Wavelength [ Angs ] ? 5000
Type of recording sources. We have the choices:
Both    SPHERICAL          0
Source  PLANE,             image SPHERICAL  1
Source  SPHERICAL,         image PLANE      2
Source  PLANE,             image PLANE      3
Source type [ 0-3 ]. Then ? 0
The SPHERICAL source can also be specified to be CYLINDRICAL, with axis perpendi
cular to recording plane.
Use:
None    Cylindrical          0
Source  Cylindrical,         image Spherical  1
Source  Spherical,          image Cylindrical  2
Both    Cylindrical          3
Cylindrical [ 0-3 ] ? 0
Sources REAL/ VIRTUAL:
EnS real,    ExS real  0
EnS real,    ExS virtual:  1
EnS virtual, ExS real:  2
EnS virtual, ExS virtual  3
Then ? 1

```

## MENU:

Refractive Index		Optical Element 1
in object space		1.
in image space		1.
Fresnel Zone Plate		YES
Define hologram		Optical Element 1
"left" distance (cm)		10.
incidence angle	0.0	
azimuth from +Y [CCW]	0.0	
"right" distance (cm)		10.
incidence angle	180.	
azimuth from +Y [CCW]	0.0	
SP = spherical, PL = plane		
Pattern type		SPSP
V = virtual, R = real		
Source type		R/V
SP = spherical, CL = cylinder		
Cylindrical source		SPSP
Recording wavelength (Angs.)		5000.

**Example:**

## 4.8 Screens

PROMPT:

```

Any screens in this OE [ Y/N ] ? 1
How many in this OE [ total ] ? 1
Screen N.          1
Is this screen before mirror [ Y/N ] ? n
Distance from mirror [ absolute ] ? 250
Is Screen Carrying an Aperture Stop [ Y/N ] ? 1
Obstruction [ 1 ] or Aperture [ 0 ] ? 0
Kind of slit. Use:
0          for a rectangular slit
1          for an elliptical slit
2          for an "external" slit.
Stop shape [ 0 r, 1 e, 2 ex ] ? 0
Dimension along X ? 1
                Z ? .25
Include absorption [ Y/N ] ? 0

```

MENU:

```

View Screen/Slit Data                Optical Element 1  Screen 1

Position rel. to mirror                AFTER
Distance (abs) from mirror            250.0000000000
Aperturing                            YES
Open slit/ solid stop                 SLIT
Aperture shape                        RECTANGULAR
Slit width/ x-axis                    1.000000000000
Slit height/ z-axis                   0.250000000000
Absorption                             NO
Thickness [ CM ]                      n/a 0.000000000000E+00
Opt. Const. File-name                 n/a NONE SPECIFIED

      Goto Screen/Slit (+)

```

Although represented as a separate object type, a screen must be attached to an optical element – it cannot stand alone.

A screen in SHADOW has a combination of three basic functions: to serve as

- an extra image plane/view port.
- an aperture or obstruction to the beam.
- an energy filter.

For all cases, SHADOW needs the absolute distance from the optical element in consistent length units and whether the screen is before or after the optical element. For a view port, that is all that is needed. SHADOW will take a snapshot of the beam at the given location and save it to a binary file (SCREEN.XXYY). In the second case, a slit or a stop is chosen, the shape specified (RECTANGULAR or ELLIPTICAL) and the dimensions given in length units. For the case of an energy filter, the thickness of the material must be given in centimeters, and a file with the optical constants must be provided. The file is created by the utility PREREFL and requires the user to input the material composition, density and the energy range of interest.

In all cases, a binary file, plottable by SHADOW utilities is created.

**Note:** It is recommended to define your screens in the actual order they appear in the optical system. For example, if the element has a screen at the exit plane and a screen that represents a slit or filter before the element, the screens should be defined so that screen 1 is before the element and screen 2 is the one located at the exit plane. Otherwise strange results may be noticed.

---

**Example:** In the example of the six meter TGM, screens were put in the system for future use as filters or to demonstrate the location of a valve or other opening to determine whether or not the light would be restricted. They can also serve as extra exit or entrance slits or pinholes.

## Chapter 5

# Optical Properties

SHADOW can (will, does) ray-trace a system without any regard to the energy or intensity of the rays. At the end of a system you can have “good” rays that in reality have no intensity. SHADOW is really keeping track of two aspects of the light - the geometrical solution and the spectral(?) solution. Up to now we have mainly considered the geometrical aspects of the elements.

At times the intensity of the final image is important. In this case the interaction of the light with a specified material can be taken into consideration.

PROMPT:

```

Reflectivity of Surface. SHADOW may solve the Fresnel equations locally.
Available options: 'No reflectivity' ..... 0
Full polarization dependence ..... 1
No " " ..... 2
Reflectivity mode [ 0,1,2 ] ? 1

Optical constants from file ( for multi-line source ) ..... 0
Optical constants from keyboard (single-line source ) ..... 1
Define multilayer from file ..... 2
Optical Constant Source: [file=0,tt:=1], multilayer [2] ? 0
File with optical constants ?
GOLD.DAT

```

MENU:

```

Optical Constants                               Optical Element 1
Reflectivity mode                               POLARIZED
Source of Reflectivity                          FILE                               d
File name                                        GOLD.DAT
Mlayer thick. vary as cosine (+) n/a NO
Alfa                                             n/a 0.00000000000000E+00
Gamma                                           n/a 0.00000000000000E+00

Use FILE TT MLAYER (Return)

```

Each ray is generated with appropriate A vectors such that  $A^2 = 1$  at the source. By default,



---

SHADOW will not modify this during tracing; for the no reflectivity option, the program assumes that 100% of the light is reflected. In situations where the optic is coated with a single material or a multilayer the user may want the attenuation of the light calculated.

For both types of mirror coatings, SHADOW has three reflectivity options; no reflectivity, full polarization dependence, no polarization dependence.

**No reflectivity** “No reflectivity” in prompt or OFF in MENU, assumes 100 % of the light is reflected. This option tells SHADOW not to do reflectivity calculations (the exception is for crystals. See page 51 for more information.).

**Full Polarization dependence** “Full Polarization dependence” or POLARIZED, does the reflectivity calculations with polarization split into its parallel and perpendicular components. This makes the most sense when the user has selected full polarization at the source (all 18 columns).

**No Polarization dependence** “No Polarization Dependence” or SCALAR does not split the parallel and perpendicular components, but instead saves the effective reflectivity.

In either of the last two options, one must supply some parameters detailing the material to be used. The parameters can come from any of three places:

- a file created by the SHADOW utility PREREF. Good for a continuous or multi-line energy source where  $\alpha$  and  $\gamma$  are not constant over the energy range of interest. Requires the material composition and density. Must at least cover the energy range of the source, can cover a larger range (in this way the material file can be used in more than one optical system).
- alpha ( $\alpha$ ) and gamma ( $\gamma$ ) from the keyboard for a single energy source, or  $\alpha$ ,  $\gamma$  constant over the desired energy range.

$$\epsilon = 1 - \alpha + i * \gamma$$

- a file created by the SHADOW utility PRE\_MLAYER containing parameters for a multilayer. The multilayer can be constant or graded. The multilayer is specified by the materials of the substrate and the alternating layers (either elements or compounds) density and composition. The thickness of the individual layer pairs is also entered. More information on PRE\_MLAYER is given in the User’s Guide to the Utilities.

---

**Example:**

For a given system, the following information was recorded in the EFFIC.XX file:

Of a total of 5000 rays, of which 4744 formed the input set  
0 were out of the mirror N. 1

The mirror collects 1.0000 of the incoming flux.

The average reflectivities are :

S-pol 0.67986

P-pol 0.67513

Total 0.67749

The overall efficiency of the mirror is : 0.67749

## **Chapter 6**

# **Misalignments to the system**

## 6.1 Source Movement

PROMPT:

```

The Optical Element and the the relative mirror are now fully
defined. The mirror pole is now located at the "center" of the
optical element. It is possible to override this situation and
"move" the mirror without affecting the rest of the system.
It is also possible to move the "source" without affecting the
rest of the system.
The movements are expressed in the DEFAULT Mirror Ref. Frame.
so that if you move BOTH source and mirror the relative
movement is the vector sum of the individual ones.
A word of caution: SOURCE movements and MIRROR movements are
NOT equivalent from the point of view of the whole system.
Do you want to move the Source [ Y/N ] ? 1
Source movements in SOURCE REFERENCE FRAME.
CW rotations are (+) angles.
X-offset ? .25
Y-offset ? 0
Z-offset ? 0
X-rotation ? 0
Y-rotation ? 0
Z-rotation ? 0
Source rotation around Z-axis. CCW is > 0 0
Source Distance from Pole ? 2000
Incidence Angle [ degrees ] ? 88
The following OFFSETS are applied in the MIRROR
reference frame.
Source offset in [ x ] ? 0
                  [ y ] ? 0
                  [ z ] ? 0

```

MENU:

```

Source Movements                               Optical Element 1
Source moved                                   r/o YES
Angle of incidence                             88.0000000000
Distance from mirror                           2000.000000000
Z-rotation                                     0.0

In MIRROR reference frame:
  offset X                                     0.0
    Y                                           0.0
    Z                                           0.0

In SOURCE reference frame:
  offset X                                     0.250000000000
    Y                                           0.0
    Z                                           0.0
  rotation [ CCW ] around X                    0.0
                                Y                0.0
                                Z                0.0

```

---

It may be desirable to examine changes in an image as the source is moved with respect to the rest of the system. Here “source” means the incoming beam either from the actual source, or from the continuation plane prior to any OE. The movement of the source is specified by offsets in the X,Y,Z coordinate system with respect to either the source or the OE upon which the source is incident, and by rotations of the source around the X,Y and Z axes. The rotations are counterclockwise if looking along the axis towards the origin. The source movement is best executed in MENU mode, since the entire OE need not be redefined. The prompt procedure is included for the sake of completeness.

---

**Example:** An obvious, but useful application of the source movement option is to determine the tolerance of an optical system (beamline) to position changes of the source beam. An example of the “correct” and moved final image is shown below.

## 6.2 Mirror Movement:

PROMPT:

```

--- Mirror rotations and position. ---
We define three angles, as rotations around the three axis.
These rotation are defined in the program as corrections to
the mirror nominal position; that is, they modify the mirror
position relative to the Default Mirror Reference Frame, where
all the calculations are performed. Remember that rotations
do NOT commute. I apply them in the same order of entry.
CW ROTATIONS are (+) angles. A translation can be also applied to the
mirror.
Do you want to move the mirror itself [ Y/N ] ? 1
Rotation around X axis [ degrees ] ? .003
      Y ? .003
      Z ? 0
Mirror Offset. In X ? 0
      Y ? 0
      Z ? 0

```

MENU:

```

Displacements                               Optical Element 1
Mirror moved                               r/o YES
Mirror Offset X                             0.0
      Y                                     0.0
      Z                                     0.0
Mirror Rotat. X                             0.300000000000000E-02
      Y                                     0.300000000000000E-02
      Z                                     0.0

```

In analyzing a system, it is sometimes useful to study how the beam is affected by moving one or more OEs without redefining the whole system. The mirror movement is determined by offsets and rotations in the mirror reference frame. Recall that the Z-axis points in the direction of the mirror pole. Rotations are performed in the same way as the source: counterclockwise if looking along the axis towards the origin. Source and mirror movements are NOT equivalent with respect to the whole system.

---

**Example:** In a real system, mirror misalignment is unavoidable to some degree. Suppose that given a maximum rotation error of 10 arc seconds (about 0.003 degrees) about the X and Y axes we wish to examine the effects on image quality and position. We may “misalign” some of the OEs without changing the general setup by moving the mirrors in MENU mode as shown in the example. The PROMPT mode is not as convenient, since everything must be reentered, but is included for completeness.